



2014 / 2
Catalog

A-Z Index

Adı / Name Sayfa / Page

32 Te-Beta	52
32 Zeta	52
Açık Flanş	105
Açılı Bağlantı	105
Akasya	66
Aİ	94
Antik	77
Antik Dügme	96
Antik V	79
Antik Yay	78
Antika	78
Aral	77
Aras	58
Aras Dügme	96
Arda	70
Arit	65
Arit Dügme	96
Arma	16
Armi	57
Arsi	23
Artis	69
Arıya	28
Ata	80
Avcı Askı	101
Axis	44
Ay Portmanto	102
Ayaklı Düz	79
Ayaklı Noktalı	73
Ayaklı S	82
Ayaklı Yunus	71
Ayaz	62
Ayıldız	90
Bafra	28
Balina	74
Bebek Askı	99
Beko	61
Bella	14
Bessi	23
Beta	39
Beta Askı	54
Beta Dügme	53
Beta Portmanto	54
Büyük Kurbağa Askı	98
Büyük Sarıklı Askı	98
C Kulp	18
Cemre	76
Çekme	76
Çiçekli Dügme	97
Çizgi	13
Çubuk	95
D Kulp	17
Damla	31
Damla Dügme	97
Daxi	22
Deko	46
Delta	44
Dersi	8
Desen-T	20
Desi	37
Dima	35
Dima Dügme	35
Diva	27
Düz Askı	99
Düz Ayak	104
Düz Dügme	97
Düz Kulp	88
E Kulp	64
E Ayaklı Noktalı	84
Ete	86
Eğri Ayak	104
Eko Konik Ayak	104
Eko Vidalı Flanş	105
Ekol	92
Ekoras	13
Elif	88
Elsi	25
Esti	26
Eta	60
Eta Portmanto	103
Exi	40
Fama	9
Fama-S	10
Fama-X	9
Fatsa	7
Fatsa-D	7

Adı / Name Sayfa / Page

Fiba	36
Fil Ayağı	89
Fiyaka	66
Gama	69
Gömme	50
Haliç	58
Haliç Dügme	96
Hilal	59
Hilal Askı	100
Işık	81
Işık Askı	101
İkon	49
İnce Yay	89
İstanbul	65
İstanbul Askı	100
İstanbul Portmanto	102
Joker	64
K365	83
K405	83
Kale	11
Kalın Yay	82
Kamer	59
Kapaklı Flanş	105
Kapalı Flanş	105
Kardin	15
Kare Boy	30
Kare Dügme	53
Kare Noktalı	85
Kare-Te	56
Karsi	22
Kavele Çivi	103
Kelebek	70
Kelebek Mnetese	103
Kıda	6
Klas	17
Klasik Askı	98
Klasik Portmanto	103
Konik Ayak	104
Koza	10
Kozma	16
Kr	94
Kros	32
Küçük Kurbağa Askı	98
Lada	47
Lades	91
Lagün	71
Lale Askı	100
Lama	95
Lara	29
Latin	12
Lena	60
Lexi	21
Lira	42
Logo	72
Loto	39
Lotus	37
Lüks Askı	98
Lüks Çizgili Askı	99
M Kulp	75
M Çiçekli	87
M Noktalı	87
Maça	41
Maki	40
Maki Dügme	53
Malta	5
Mardin	14
Marka	50
Maxi	47
Mazda	15
Mega	29
Megan	19
Megan-D	19
Mermi Dügme	97
Mersi	25
Meta	67
Moda	48
Moda Yay	24
N Kare	32
Narin	62
Nata	61
Nİİ	51
Noktalı Askı	100
Noktalı Dügme	97
Noktalı Portmanto	102
Noktalı Yay	81

Adı / Name Sayfa / Page

Okey	68
Papatya	20
Penta	46
Pera	68
Pera Dügme	53
Persi	6
Petek	75
Petek Dügme	97
Polo	21
Puma	34
Redif	38
Redif Askı	55
Redif Portmanto	55
Reis	38
Reis Askı	55
Reis Portmanto	55
Rena	41
Riga	27
Rima	36
Rita	42
Rota	45
Roza	45
S Kulp	85
Samsun	5
Sembol	43
Sera	73
Simge	48
Simge Yay	24
Star Askı	101
Star Portmanto	101
Stil	49
Şafak Dügme	97
Şah Askı	98
T Bağlantı	105
T Boy	30
T Kulp	63
Tavşan Askı	100
Taxim	35
Te-Beta	51
Te-Beta Askı	55
Te-Beta Portmanto	54
Te-Kare	56
Tena	11
Tepe	12
Tetra	43
Tuğra	26
U Kulp	63
Üçgen Askı	101
Üçgen Portmanto	103
V Askı	99
Vega	33
Venus	74
Vera	34
Vesta	33
Vidalı Flanş	105
Vidasız Flanş	105
Vita	67
Vita Askı	54
Vita Dügme	53
Vita Portmanto	54
Yaka	80
Yaprak Askı	99
Yaprak Dügme	97
Yaprak Portmanto	103
Yatay	72
Yay	57
Yay Askı	102
Yay Dügme	97
Yay Portmanto	102
Yeni Efe	86
Yeni Ege	91
Yeni Noktalı	84
Yeni Yatay	92
Yeni Yay	93
Yeni Yunus	93
Yıldız	18
Yonca	90
Yonca Dügme	97
Yuma	8
Zigzag	31

Kod Index

A120	102
A122	98
A124	98
A126	100
A128	98
A132	98
A134	99
A136	98
A146	98
A148	99
A150	99
A164	99
A166	101
A168	101
A175	99
A180	100
A190	100
A240	100
A360	101
A405	100
A500	55
A510	101
A805	54
AB	105
ABT	54
AK	66
AL	94
AR	28
ARD	55
ARS	55
AS	23
AX	44
B504	105
B506	105
BF	28
BK	61
BL	14
BS	23
BT	39
CK	76
C	95
Ç404-Ç402	103
D10	104
D100	96
D170	97
D240	97
D265	97
D275	97
D380	97
D400	97
D605	97
D625	97
D700	97
D745	96
D800	96
D805	96
D815	97
DBT	53
DK	46
DKR	53
DKS	32
DM	35
DMD	35
DMK	53
DPR	53
DR	8
DT	44
DV	27
DVT	53
DX	22
E	64
E10-E12	104
EL	25
ES	26
ET	60
EX	40
F01	105
F02	105
F03	105
FB	36
FE02	105
FK	66
FM	9
FMS	10
FMX	9

G	50
IK	49
İST	65
K100	57
K107	20
K109	20
K120	82
K140	12
K160	16
K165	12
K180	82
K190	93
K195	17
K200	18
K210	31
K215	26
K220	31
K250	73
K260	18
K275	88
K305	86
K360	81
K365	83
K375	79
K385	86
K400	13
K401	17
K405	83
K415	81
K420	93
K460	77
K470	77
K500	51
K500-32	52
K510	42
K520	41
K525	41
K530	42
K5-K8-K10-K12	104
K600	72
K605	75
K615	7
K616	7
K630	19
K631	19
K650	90
K660	71
K740	74
K745	65
K750	70
K770	74
K775	69
K780	72
K785	59
K790	59
K795	79
K800	58
K801	13
K805	58
K810	78
K815	78
K825	71
K830	80
K840	69
K850	91
K860	70
K885	75
K890	57
K895	62
K900	92
K905	62
K910	76
K915	64
K920	68
K935	80
K940	37
K945	51
KB	30
KD	6
Klas	11
KM	16
KN	15
KR	94
KRT	56
KS	22

KZ	10
LA	29
LD	47
LM	95
LN	60
LS	37
LT	39
LX	21
M110	85
M115	84
M135	89
M145	88
M150	85
M155	89
M170	90
M240	87
M265	87
M300	84
M352	103
M5-M8-M10	104
MD	48
MG	29
MK	40
ML	5
MN	14
MR	50
MS	25
MT	67
MX	47
MY	24
MZ	15
N335	91
N590	92
NK	32
NT	61
P120	102
P190	102
P240	102
P302	103
P304	102
P306	103
P308	103
P320	103
P500	54
P510	101
P805	54
PBT	54
PL	21
PM	34
PN	46
PR	68
PRD	55
PRS	55
PS	6
RD	38
RG	27
RM	36
RS	38
RT	45
RZ	45
SB	43
SM	48
SN	5
SR	73
ST	49
SV	24
T	63
T1	105
TB	30
TK	56
TN	11
TR	43
TX	35
U	63
VG	33
VR	34
VS	33
VT	67
YM	8
ZT	52

Mobilyalarımıza Deger Katar...



METAX

MOBİLYA AKSESUARLARI



Mobilyalarımıza Deger Katar...

Ölçüler (mm) Sizes	Metal Renkler Metal Colors	Plastik Renkler Plastic Colors
32	24 Inox	04 Siyah
128	02 Krom	28 Bambu
160	22 Mat Krom	20 Beyaz
192		08 Kırmızı
224		21 Beyaz yıldız
320		09 Yeşil
		23 Siyah Zebra
		26 Beyaz Zebra
		29 Kırmızı Zebra

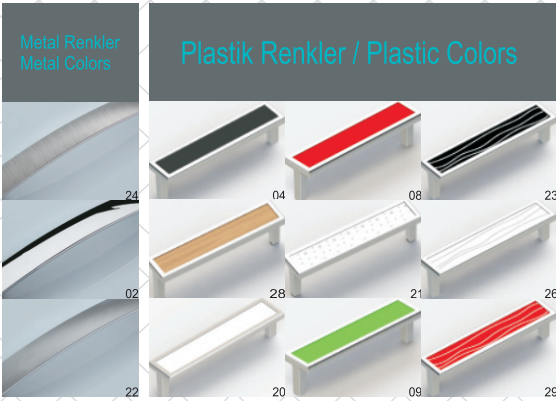

Kod Code
SN

Samsun

Ölçüler (mm) Sizes	Metal Renkler Metal Colors	Plastik Renkler Plastic Colors
160	24 Inox	04 Siyah
224	02 Krom	28 Bambu
320		20 Beyaz
		08 Kırmızı
		21 Beyaz yıldız
		09 Yeşil
		23 Siyah Zebra
		26 Beyaz Zebra
		29 Kırmızı Zebra



Kod Code
ML

Malta

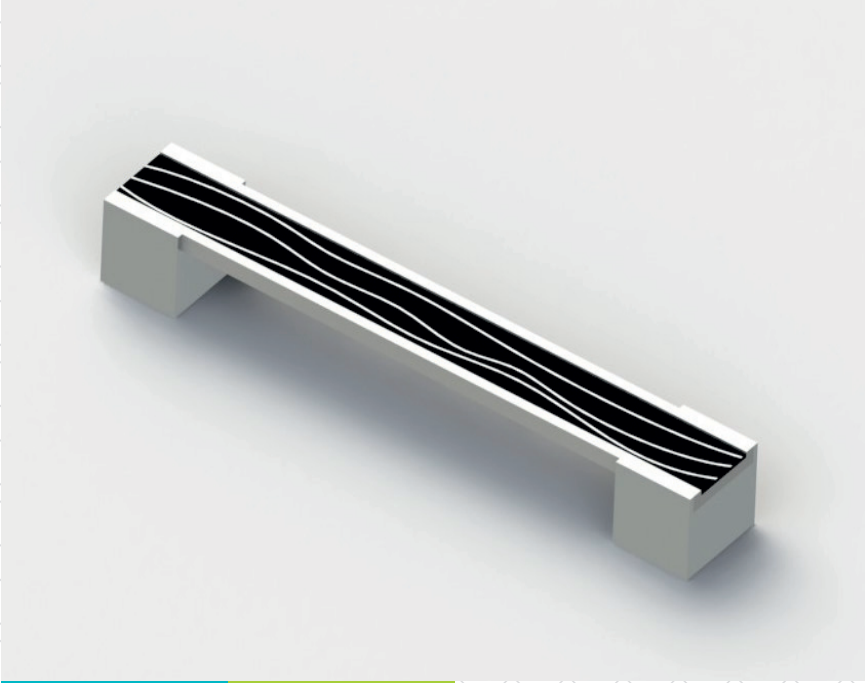

Ölçüler (mm)
Sizes

160
192
224
256
320

Metal Renkler
Metal Colors

24 İnox
02 Krom

Plastik Renkler
Plastic Colors

04 Siyah
28 Bambu
20 Beyaz
08 Kırmızı
21 Beyaz yıldız
09 Yeşil
23 Siyah Zebra
26 Beyaz Zebra
29 Kırmızı Zebra

Metal Renkler
Metal Colors



Plastik Renkler / Plastic Colors

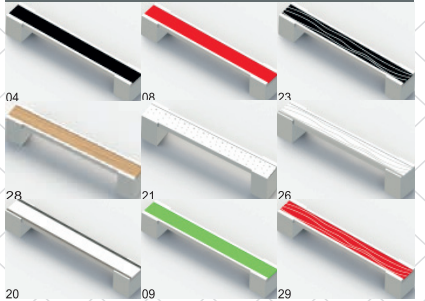

Persi

Kod
Code
PS



Ölçüler (mm)
Sizes

32
128
160
224
320

Metal Renkler
Metal Colors

24 İnox
02 Krom
22 Mat Krom

Plastik Renkler
Plastic Colors

04 Siyah
28 Bambu
20 Beyaz
08 Kırmızı
21 Beyaz yıldız
09 Yeşil
23 Siyah Zebra
26 Beyaz Zebra
29 Kırmızı Zebra

Metal Renkler
Metal Colors



Plastik Renkler / Plastic Colors

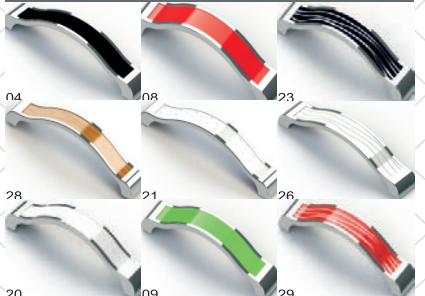

Kıda

Kod
Code
KD

Ölçüler (mm)
Sizes

32
128
160
224
320

Metal Renkler
Metal Colors

24 Inox
02 Krom
22 Mat Krom

Metal Renkler
Metal Colors

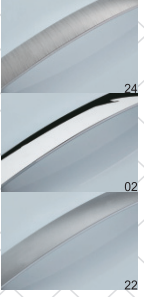

32 mm

Kod
Code
K615

Fatsa

Ölçüler (mm)
Sizes

32
128
160
224
320

Metal Renkler
Metal Colors

24 Inox
02 Krom
22 Mat Krom
18 Antik Bakır
23 Antik Sarı

Metal Renkler
Metal Colors

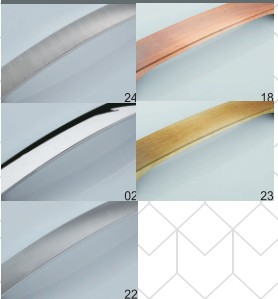

32 mm

Kod
Code
K616

Fatsa-D

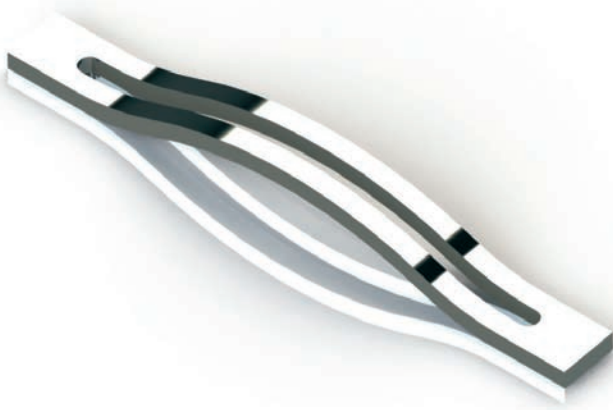

Ölçüler (mm)
Sizes

160
192
224
256
320

Metal Renkler
Metal Colors

24 İnox
02 Krom

Metal Renkler
Metal Colors



Yuma

Kod
Code
YM

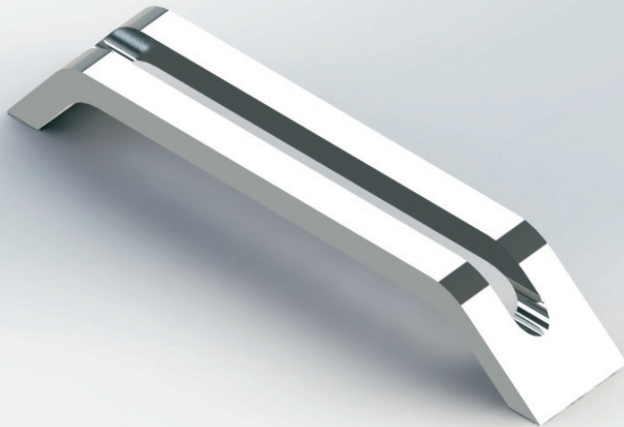

Ölçüler (mm)
Sizes

192
288
320

Metal Renkler
Metal Colors

24 İnox
02 Krom

Metal Renkler
Metal Colors



Dersi

Kod
Code
DR

Ölçüler (mm)
Sizes

224
288
320
352

Metal Renkler
Metal Colors

24 Inox
02 Krom

Metal Renkler
Metal Colors

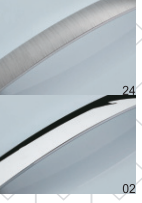

Kod
Code

FM

Fama

Ölçüler (mm)
Sizes

160
192
224
256
288
320

Metal Renkler
Metal Colors

24 Inox
02 Krom

Metal Renkler
Metal Colors

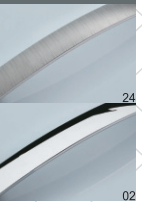

Sol \ L

Sağ \ R

Kod
Code

FMX

Fama-X



Ölçüler (mm)
Sizes

160
192
224
256
288
320

Metal Renkler
Metal Colors

24 İnox
02 Krom

Metal Renkler
Metal Colors



Fama-S

Kod
Code
FMS

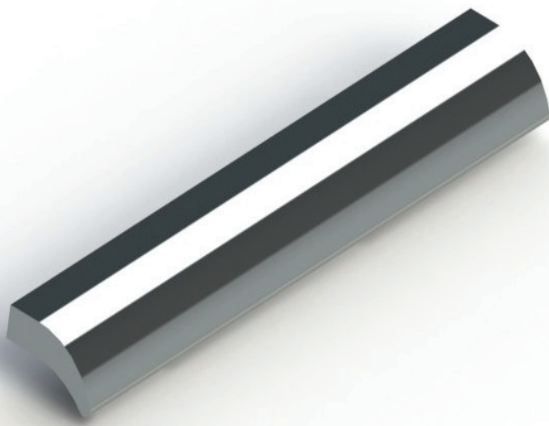

Ölçüler (mm)
Sizes

160
192
224
256
288
320

Metal Renkler
Metal Colors

24 İnox
02 Krom

Metal Renkler
Metal Colors

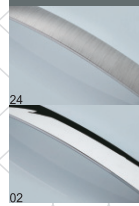

Koza

Kod
Code
KZ

Ölçüler (mm)
Sizes

128
160
192
224
256

Metal Renkler
Metal Colors

24 Inox
02 Krom
22 Mat Krom

Plastik Renkler
Plastic Colors

02 Krom
04 Siyah
08 Kırmızı
10 Sarı
19 Füme
20 Beyaz

Metal Renkler
Metal Colors



Plastik Renkler / Plastic Colors

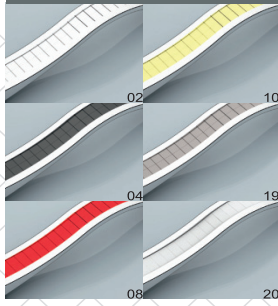

Kod
Code

KL

Kale

Ölçüler (mm)
Sizes

96
128
160
192
224

Metal Renkler
Metal Colors

24 Inox
02 Krom
22 Mat Krom

Plastik Renkler
Plastic Colors

02 Krom
04 Siyah
08 Kırmızı
10 Sarı
19 Füme
20 Beyaz

Metal Renkler
Metal Colors



Plastik Renkler / Plastic Colors

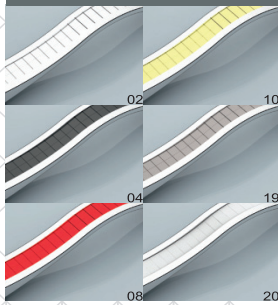

Kod
Code

TN

Tena

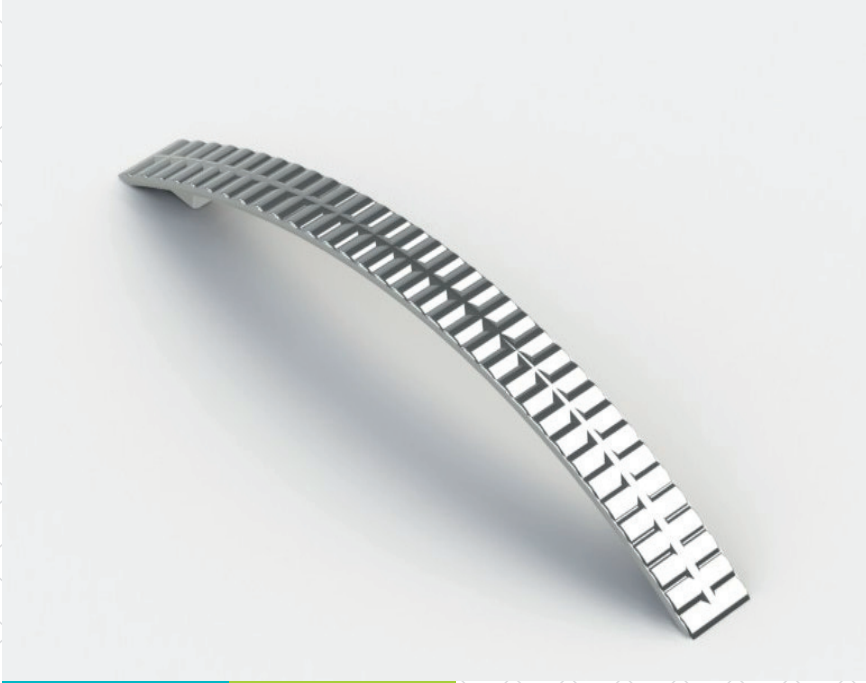

Latin

**Kod
Code
K140**

**Ölçüler (mm)
Sizes**

160
224

**Metal Renkler
Metal Colors**

24 İnox
02 Krom
22 Mat Krom
17 Saten
18 Antik Bakır
23 Antik Sarı

**Metal Renkler
Metal Colors**

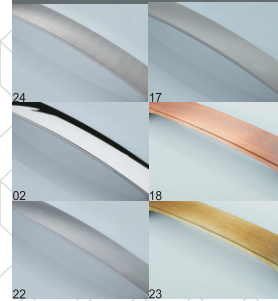

Tepe

**Kod
Code
K165**

**Ölçüler (mm)
Sizes**

128
192

**Metal Renkler
Metal Colors**

24 İnox
02 Krom
22 Mat Krom
17 Saten
18 Antik Bakır
23 Antik Sarı

**Metal Renkler
Metal Colors**

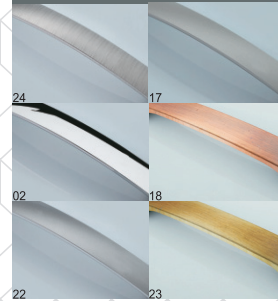

Ölçüler (mm)
Sizes

128
160
192
224

Metal Renkler
Metal Colors

25 Krom Inox
24 Inox
02 Krom

Metal Renkler
Metal Colors

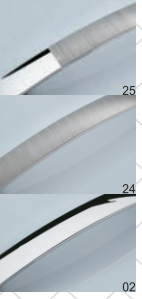

Kod
Code
K801

Ekoras

Ölçüler (mm)
Sizes

96
128
160
192
224

Metal Renkler
Metal Colors

24 Inox
02 Krom

Metal Renkler
Metal Colors

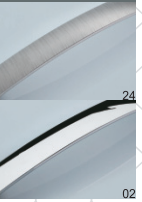

Kod
Code
K400

Çizgi

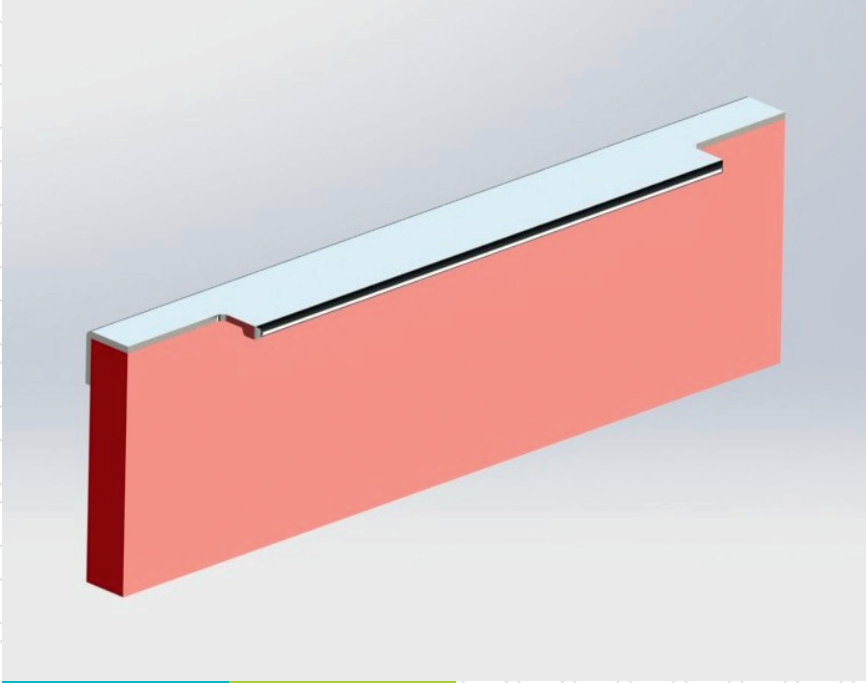

Ölçüler (mm)
Sizes

247
297
347
397
447
497
547
597

Metal Renkler
Metal Colors

24 İnox
02 Krom

Metal Renkler
Metal Colors



Bella

Kod
Code
BL



Ölçüler (mm)
Sizes

247
297
347
397
447
497
547
597

Metal Renkler
Metal Colors

24 İnox
02 Krom

Metal Renkler
Metal Colors

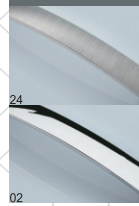

Mardin

Kod
Code
MN

Ölçüler (mm)
Sizes

247
297
347
397
447
497
547
597

Metal Renkler
Metal Colors

24 Inox
02 Krom

Metal Renkler
Metal Colors

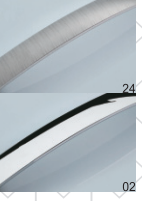

Kod
Code

KN

Kardin

Ölçüler (mm)
Sizes

160
224
288
320
384
448
512

Metal Renkler
Metal Colors

24 Inox
02 Krom

Metal Renkler
Metal Colors

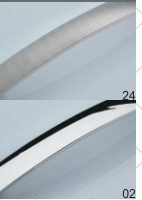

Kod
Code

MZ

Mazda



Ölçüler (mm)
Sizes

32
64

Metal Renkler
Metal Colors

24 İnox
02 Krom
22 Mat Krom
17 Saten
18 Antik Bakır
23 Antik Sarı

Metal Renkler
Metal Colors

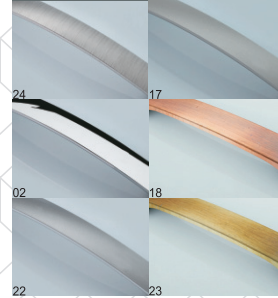

Arma

Kod
Code
K160



Ölçüler (mm)
Sizes

320

Metal Renkler
Metal Colors

22 Mat Krom

Metal Renkler
Metal Colors



Kozma

Kod
Code
KM

Ölçüler (mm)
Sizes

128
160
192
224

Metal Renkler
Metal Colors

24 Inox
02 Krom

Metal Renkler
Metal Colors

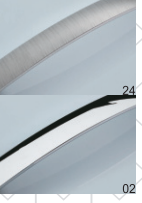

Kod
Code
K195

Klas

Ölçüler (mm)
Sizes

96
128
160
224

Metal Renkler
Metal Colors

24 Inox
02 Krom

Metal Renkler
Metal Colors

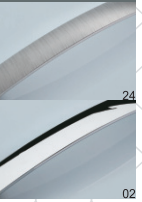

Kod
Code
K401

D Kulp



Ölçüler (mm)
Sizes

32

Metal Renkler
Metal Colors

24 İnox
02 Krom
22 Mat Krom
17 Saten
18 Antik Bakır
23 Antik Sarı

Metal Renkler
Metal Colors

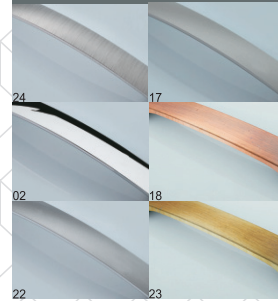

Yıldız

Kod
Code
K260



Ölçüler (mm)
Sizes

32

64

Metal Renkler
Metal Colors

24 İnox
02 Krom
22 Mat Krom
17 Saten

Metal Renkler
Metal Colors

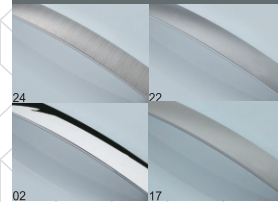

C Kulp

Kod
Code
K200

Ölçüler (mm)
Sizes

32
128
160
224
320

Metal Renkler
Metal Colors

24 Inox
02 Krom
22 Mat Krom

Metal Renkler
Metal Colors

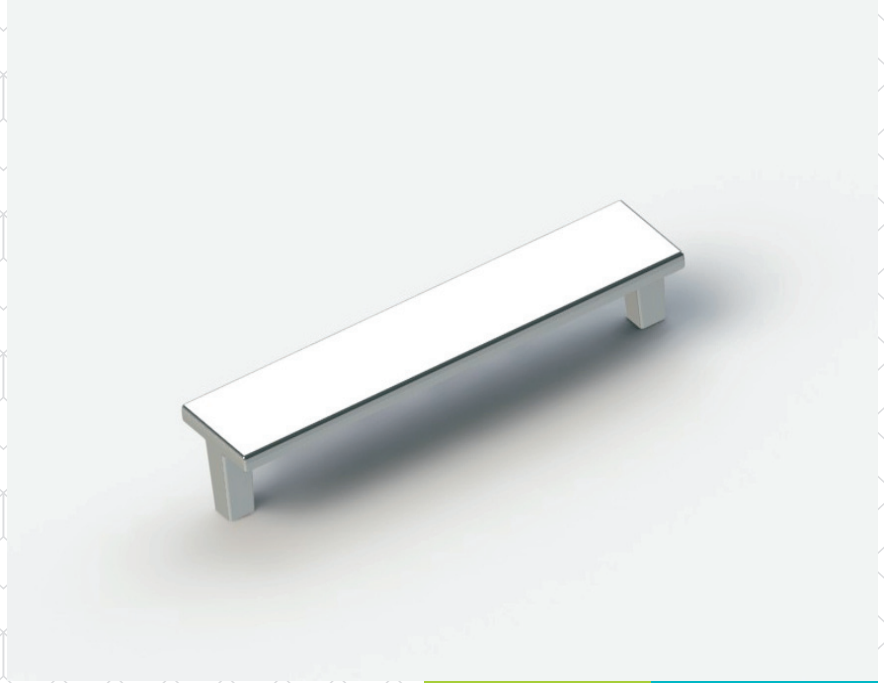
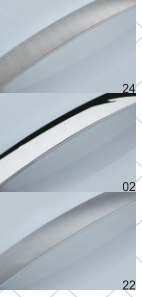

Kod
Code
K630

Megan

Ölçüler (mm)
Sizes

32
128
160
224
320

Metal Renkler
Metal Colors

24 Inox
02 Krom
22 Mat Krom
18 Antik Bakır
23 Antik Sarı

Metal Renkler
Metal Colors

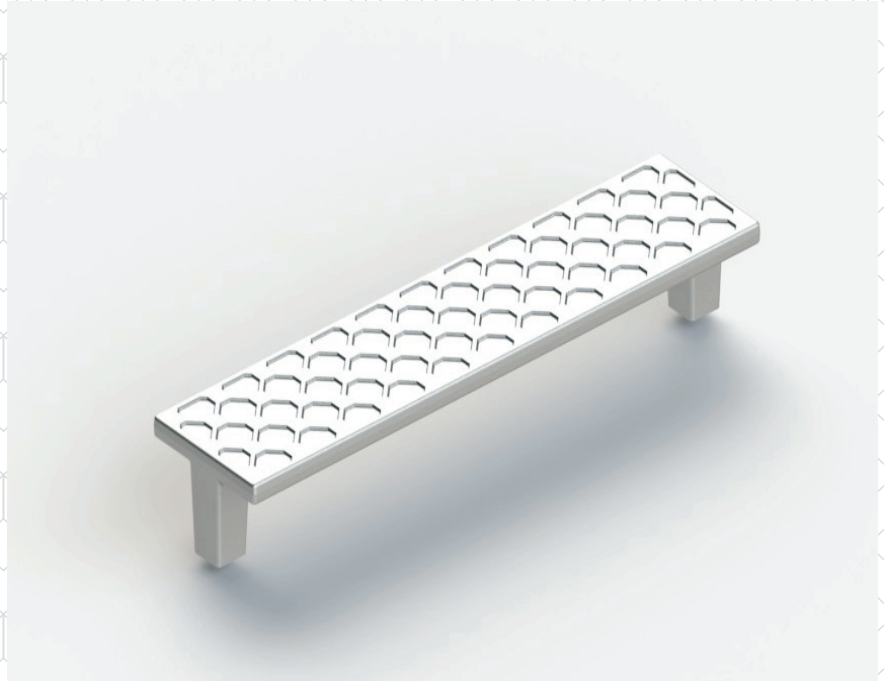
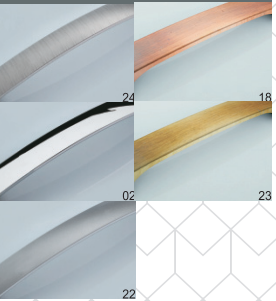

Kod
Code
K631

Megan-D



Sol | L



Sağ | R

Desen-T

Kod
Code
K107

Ölçüler (mm)
Sizes

160

Metal Renkler
Metal Colors

24 İnox
02 Krom
22 Mat Krom

Metal Renkler
Metal Colors

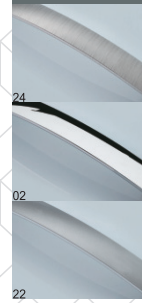

Papatya

Kod
Code
K109



Ölçüler (mm)
Sizes

96

Metal Renkler
Metal Colors

24 İnox
02 Krom
22 Mat Krom

Metal Renkler
Metal Colors

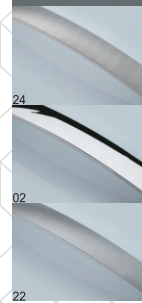

Ölçüler (mm)
Sizes

192
288
320

Metal Renkler
Metal Colors

24 Inox
02 Krom

Metal Renkler
Metal Colors

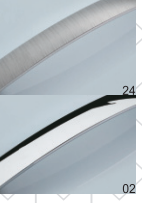

Kod
Code
LX

Lexi

Ölçüler (mm)
Sizes

224
256
288
320
352
384
416
448
480
512
544

Metal Renkler
Metal Colors

24 Inox
02 Krom

Metal Renkler
Metal Colors

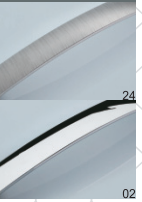

Kod
Code
PL

Polo



Ölçüler (mm)
Sizes

160
224
320

Metal Renkler
Metal Colors

02 Krom

Metal Renkler
Metal Colors



Daxi

Kod

DX



Ölçüler (mm)
Sizes

160
224
320

Metal Renkler
Metal Colors

02 Krom

Metal Renkler
Metal Colors



Karsi

Kod
Code

KS

Ölçüler (mm)
Sizes

160
224
320

Metal Renkler
Metal Colors

02 Krom

Metal Renkler
Metal Colors



02



Kod
Code

AS

Arsi

Ölçüler (mm)
Sizes

160
224
320

Metal Renkler
Metal Colors

02 Krom

Metal Renkler
Metal Colors



02

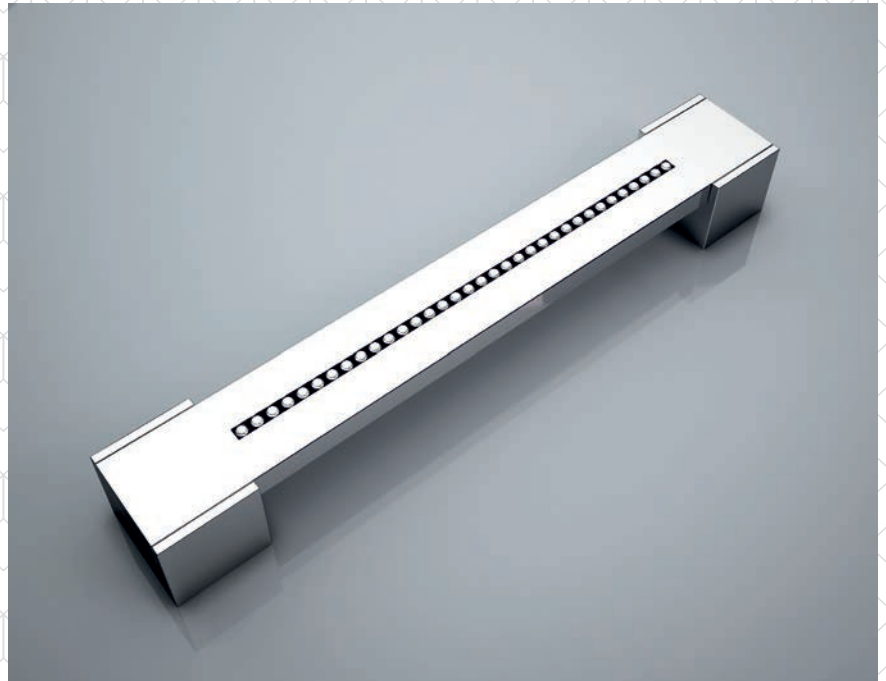

Kod
Code

BS

Bessi



Ölçüler (mm)
Sizes

192
256
288

Metal Renkler
Metal Colors

24 İnox
02 Krom

Metal Renkler
Metal Colors



Simge Yay

Kod
Code
SY



Ölçüler (mm)
Sizes

192
256
288

Metal Renkler
Metal Colors

24 İnox
02 Krom

Metal Renkler
Metal Colors

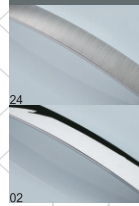

Moda Yay

Kod
Code
MY

Ölçüler (mm)
Sizes

160
224
320

Metal Renkler
Metal Colors

02 Krom

Metal Renkler
Metal Colors



02



Kod
Code

EL

Elsi

Ölçüler (mm)
Sizes

160
224
320

Metal Renkler
Metal Colors

02 Krom

Metal Renkler
Metal Colors



02

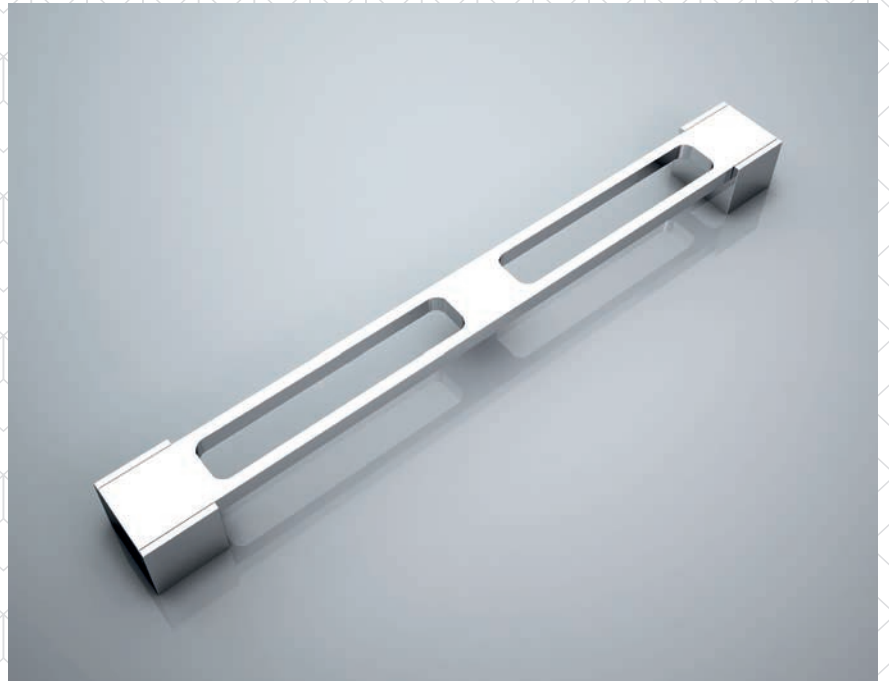

Kod
Code

MS

Mersi

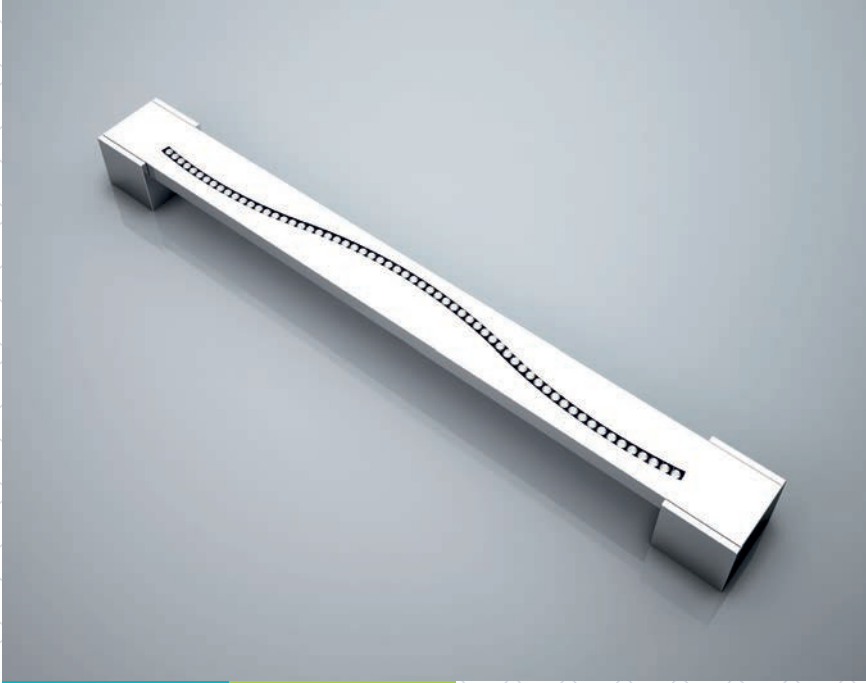

Ölçüler (mm)
Sizes

160
224
320

Metal Renkler
Metal Colors

02 Krom

Metal Renkler
Metal Colors



Esti

Kod
Code
ES



Ölçüler (mm)
Sizes

160

Metal Renkler
Metal Colors

24 İnox
02 Krom
22 Mat Krom
18 Antik bakır
23 Antik Sarı

Metal Renkler
Metal Colors

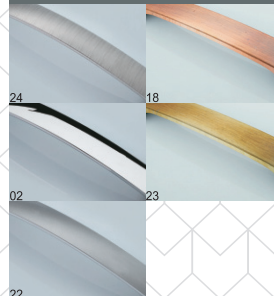

Tugra

Kod
Code
K215

Ölçüler (mm)
Sizes

160
224
320

Metal Renkler
Metal Colors

02 Krom

Metal Renkler
Metal Colors



02



Kod
Code
DV

Div

Ölçüler (mm)
Sizes

160
224
320

Metal Renkler
Metal Colors

02 Krom

Metal Renkler
Metal Colors



02



Kod
Code
RG

Riga



Ölçüler (mm)
Sizes

160
224
288

Metal Renkler
Metal Colors

02 Krom

Metal Renkler
Metal Colors



Arya

Kod
Code
AR



Ölçüler (mm)
Sizes

160
224
288

Metal Renkler
Metal Colors

02 Krom

Metal Renkler
Metal Colors



Bafra

Kod
Code
BF

Ölçüler (mm)
Sizes

160
224
288
320
384
448
512

Metal Renkler
Metal Colors

02 Krom

Metal Renkler
Metal Colors



Kod
Code
MG

Mega

Ölçüler (mm)
Sizes

96
128
160
192
224
256
288
320
352
384
416

Metal Renkler
Metal Colors

24 Inox
02 Krom

Metal Renkler
Metal Colors

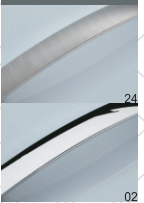

Kod
Code
LA

Lara

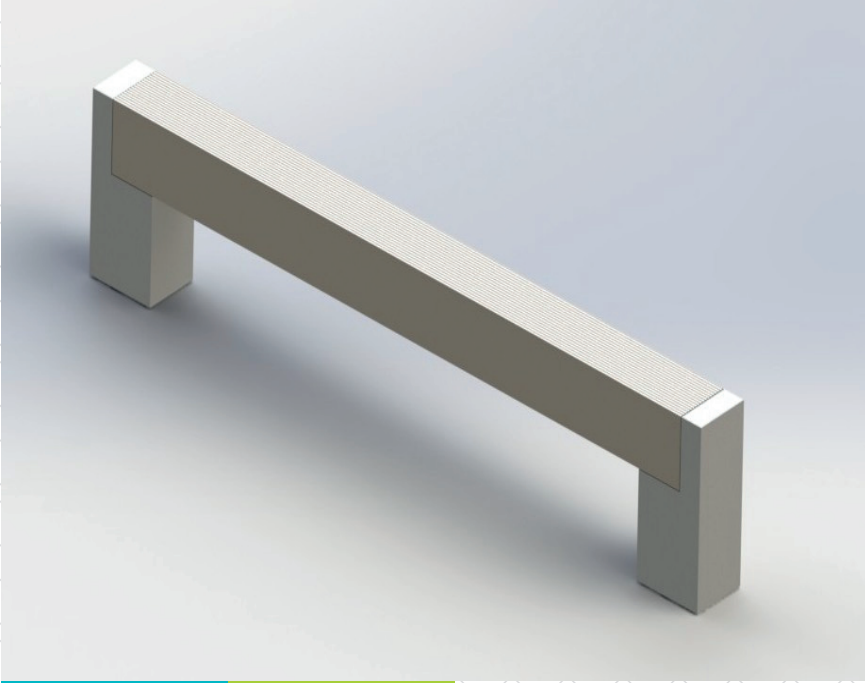

Ölçüler (mm)
Sizes

96
128
160
192
224
256
288
320
352
384
416

Metal Renkler
Metal Colors

02 Krom / 24 İnox

Kare Boy

Kod
Code
KB



Ölçüler (mm)
Sizes

128
160
192
224
256
288
320
352
384
416

Metal Renkler
Metal Colors

24 İnox
02 Krom

Metal Renkler
Metal Colors

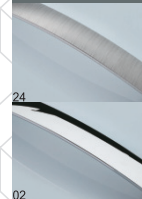

T Boy

Kod
Code
TB

Ölçüler (mm)
Sizes

192

Metal Renkler
Metal Colors

24 Inox
02 Krom
22 Mat Krom
18 Antik Bakır
23 Antik Sarı

Metal Renkler
Metal Colors

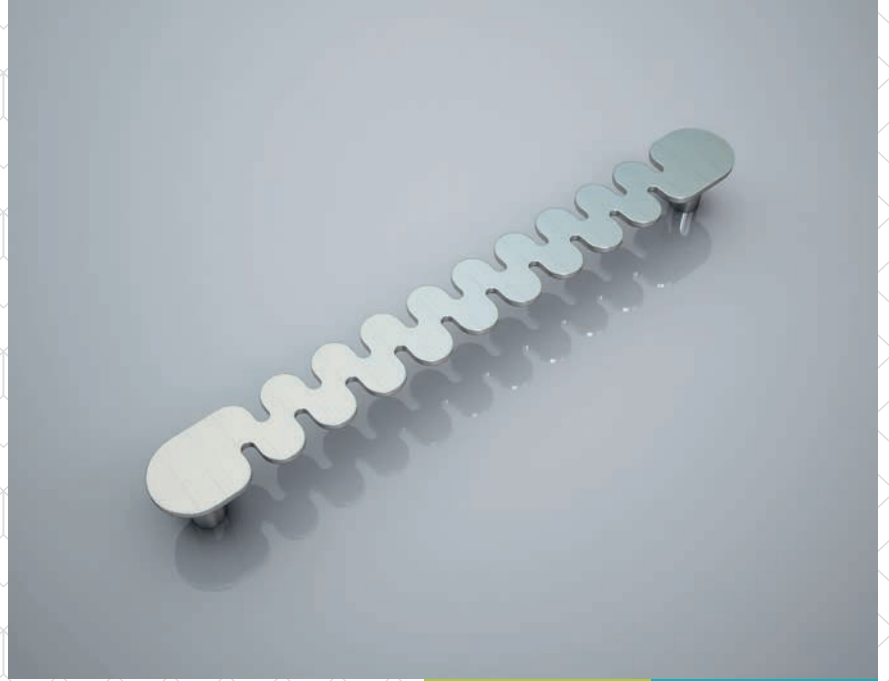
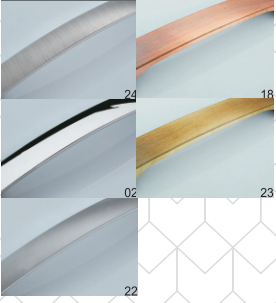

Kod
Code
K220

Zigzag

Ölçüler (mm)
Sizes

160
192

Metal Renkler
Metal Colors

24 Inox
02 Krom
22 Mat Krom
18 Antik Bakır
23 Antik Sarı

Metal Renkler
Metal Colors

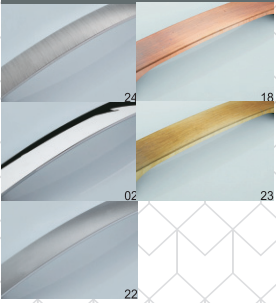

Kod
Code
K210

Damla



Ölçüler (mm)
Sizes

Metal Renkler
Metal Colors

-
24 İnox
02 Krom
22 Mat Krom
17 Saten
18 Antik Bakır
23 Antik Sarı

Metal Renkler
Metal Colors

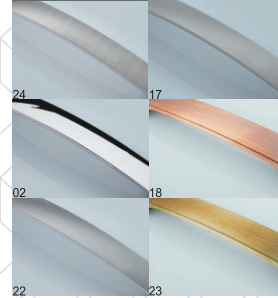

Kros

Kod
Code
DKS



Ölçüler (mm)
Sizes

Metal Renkler
Metal Colors

32
24 İnox
02 Krom
22 Mat Krom
17 Saten

Metal Renkler
Metal Colors

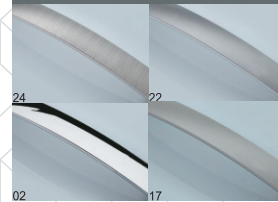

N Kare

Kod
Code
NK

32

www.metax.metax
facebook.com/metax.metax

Ölçüler (mm)
Sizes

160
192
224

Metal Renkler
Metal Colors

24 Inox
02 Krom
22 Mat Krom
17 Saten

Metal Renkler
Metal Colors

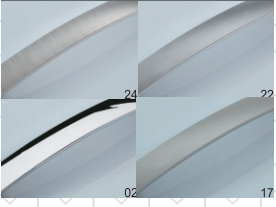

Kod
Code

VG

Vega

Ölçüler (mm)
Sizes

160
192
224

Metal Renkler
Metal Colors

24 Inox
02 Krom
22 Mat Krom

Plastik Renkler
Plastic Colors

02 Krom
04 Siyah
08 Kırmızı
10 Sarı
19 Füme
20 Beyaz

Metal Renkler
Metal Colors

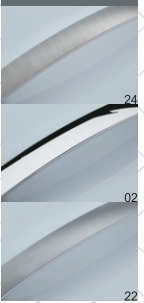

Plastik Renkler / Plastic Colors

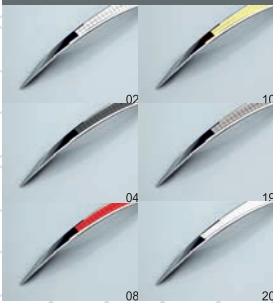

Kod
Code

VS

Vesta



Ölçüler (mm)
Sizes

128
192

Metal Renkler
Metal Colors

24 İnox
02 Krom
22 Mat Krom
17 Saten
18 Antik Bakır
23 Antik Sarı

Metal Renkler
Metal Colors

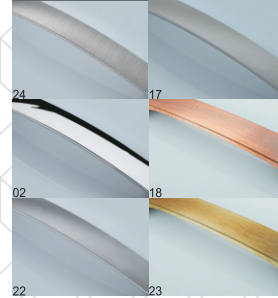

Puma

Kod
Code
PM



Ölçüler (mm)
Sizes

128
224

Metal Renkler
Metal Colors

24 İnox
02 Krom
22 Mat Krom
17 Saten
18 Antik Bakır
23 Antik Sarı

Metal Renkler
Metal Colors

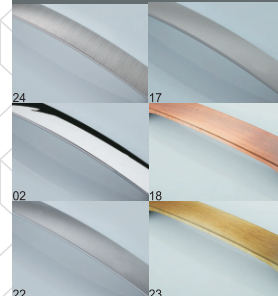

Vera

Kod
Code
VR

Ölçüler (mm)
Sizes

64
96
160
256

Metal Renkler
Metal Colors

24 İnox
02 Krom
22 Mat Krom
18 Antik Bakır
23 Antik Sarı

Metal Renkler
Metal Colors

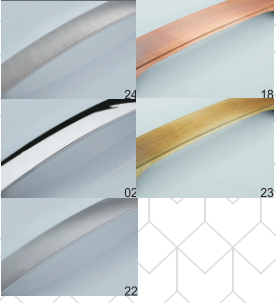

Sol / L Sağ / R DMD

Kod
Code
DMD

Dima Düğme

Kod
Code
DM

Dima

Ölçüler (mm)
Sizes

32
128
256

Metal Renkler
Metal Colors

25 Krom İnox
24 İnox
02 Krom
22 Mat Krom
17 Saten

Metal Renkler
Metal Colors

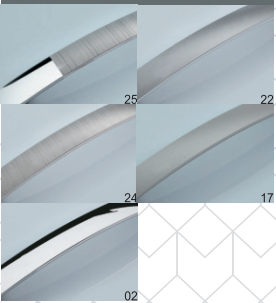

Kod
Code
TX

Taxim



Ölçüler (mm)
Sizes

192

Metal Renkler
Metal Colors

24 İnox
02 Krom
22 Mat Krom
17 Saten

Metal Renkler
Metal Colors

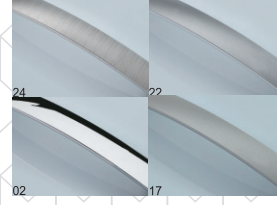

Rima

Kod
Code
RM

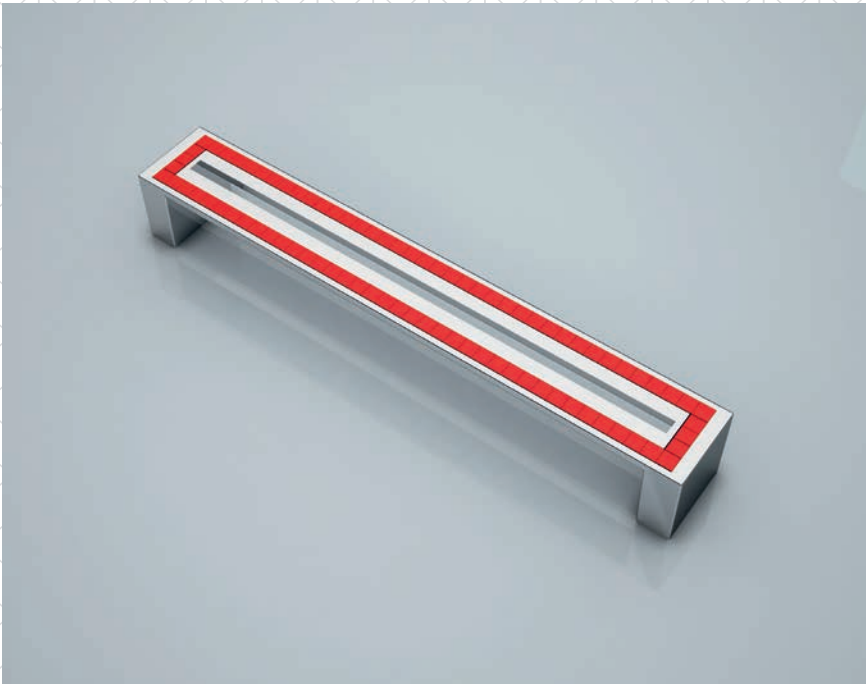

Ölçüler (mm)
Sizes

192

Metal Renkler
Metal Colors

24 İnox
02 Krom
22 Mat Krom

Plastik Renkler
Plastic Colors

02 Krom
04 Siyah
08 Kırmızı
10 Sarı
19 FÜme
20 Beyaz

Metal Renkler
Metal Colors

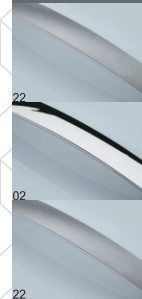

Plastik Renkler / Plastic Colors

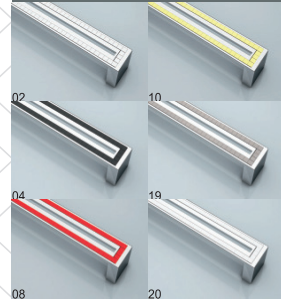

Fiba

Code
FB

Ölçüler (mm)
 Sizes

128
 160
 192
 224

Metal Renkler
 Metal Colors

24 Inox
 02 Krom
 22 Mat Krom

Plastik Renkler
 Plastic Colors

02 Krom
 04 Siyah
 08 Kırmızı
 10 Sarı
 19 Füme
 20 Beyaz

Metal Renkler
 Metal Colors

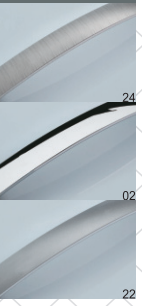

Plastik Renkler / Plastic Colors

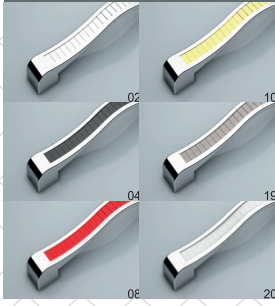

Kod
 Code
 LS

Lotus

Ölçüler (mm)
 Sizes

160
 224

Metal Renkler
 Metal Colors

24 Inox
 02 Krom
 22 Mat Krom
 17 Saten
 18 Antik Bakır
 23 Antik Sarı

Metal Renkler
 Metal Colors

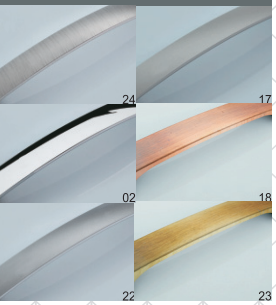

Kod
 Code
 K940

Desi

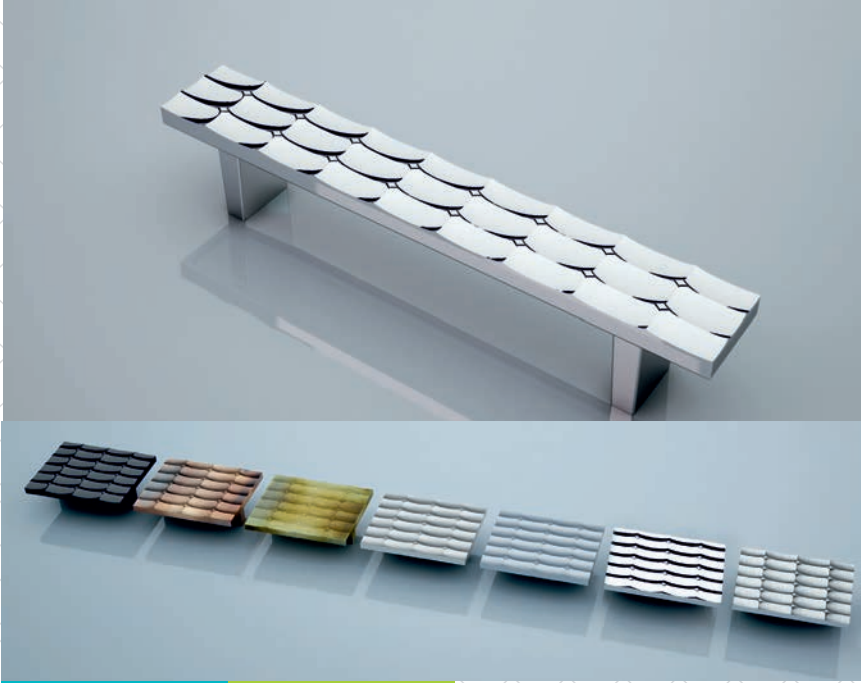

Ölçüler (mm)
Sizes

32
128
192

Metal Renkler
Metal Colors

24 İnox
02 Krom
22 Mat Krom
17 Saten
18 Antik Bakır
23 Antik Sarı

Metal Renkler
Metal Colors

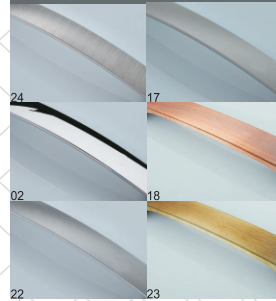

Reis

Kod
Code
RS



Ölçüler (mm)
Sizes

32
128
192

Metal Renkler
Metal Colors

24 İnox
02 Krom
22 Mat Krom
17 Saten
18 Antik Bakır
23 Antik Sarı

Metal Renkler
Metal Colors

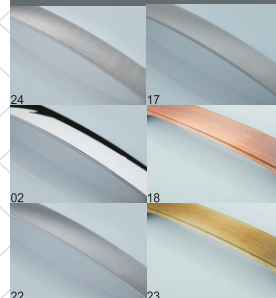

Redif

Kod
Code
RD

Ölçüler (mm)
Sizes

128
160
224
256

Metal Renkler
Metal Colors

24 Inox
02 Krom
22 Mat Krom
23 Antik Sarı

Plastik Renkler
Plastic Colors

02 Krom
04 Siyah
08 Kırmızı
10 Sarı
19 Füme
20 Beyaz

Metal Renkler
Metal Colors

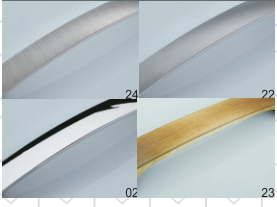

Plastik Renkler / Plastic Colors

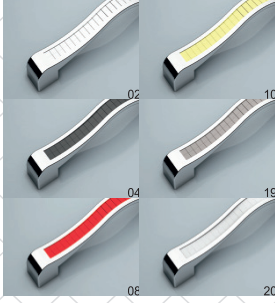

Kod
Code
BT

Beta

Ölçüler (mm)
Sizes

128
160
192
224
256

Metal Renkler
Metal Colors

24 Inox
02 Krom
22 Mat Krom

Plastik Renkler
Plastic Colors

02 Krom
04 Siyah
08 Kırmızı
10 Sarı
19 Füme
20 Beyaz

Metal Renkler
Metal Colors

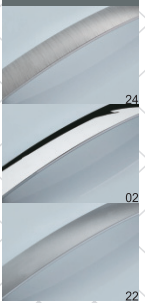

Plastik Renkler / Plastic Colors

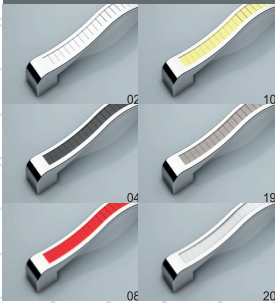

Kod
Code
LT

Loto

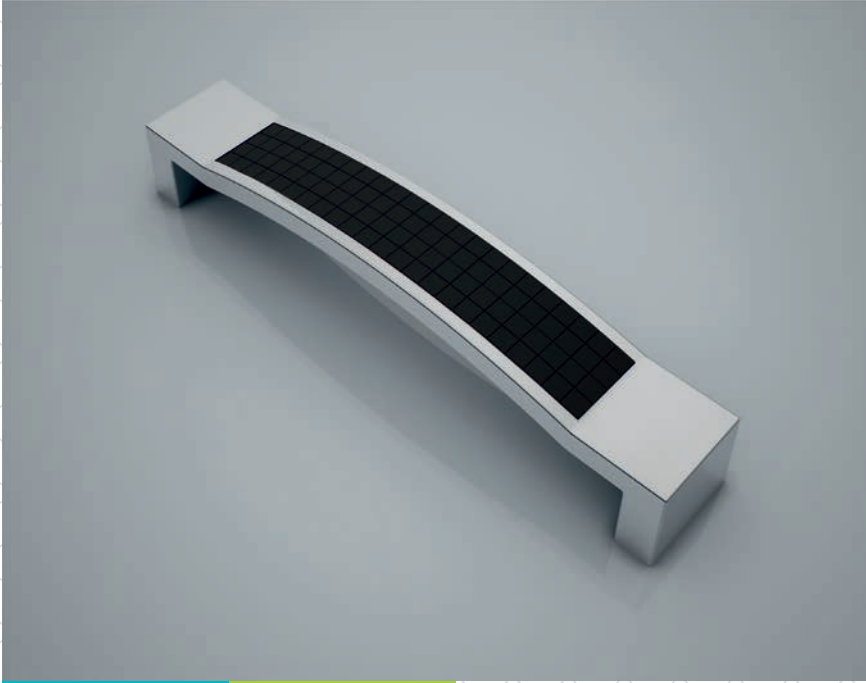

Ölçüler (mm)
Sizes

160
256

Metal Renkler
Metal Colors

24 İnox
02 Krom
22 Mat Krom

Plastik Renkler
Plastic Colors

02 Krom
04 Siyah
08 Kırmızı
10 Sarı
19 Füme
20 Beyaz

Metal Renkler
Metal Colors

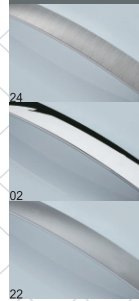

Plastik Renkler / Plastic Colors

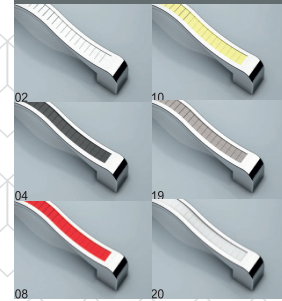

Maki

Kod
Code
MK



Ölçüler (mm)
Sizes

64
96
128
160
192
224
256
288
320
352

Metal Renkler
Metal Colors

24 İnox
02 Krom

Metal Renkler
Metal Colors



Exi

Kod
Code
EX

Ölçüler (mm)
Sizes

64
160
288

Metal Renkler
Metal Colors

24 Inox
02 Krom

Metal Renkler
Metal Colors

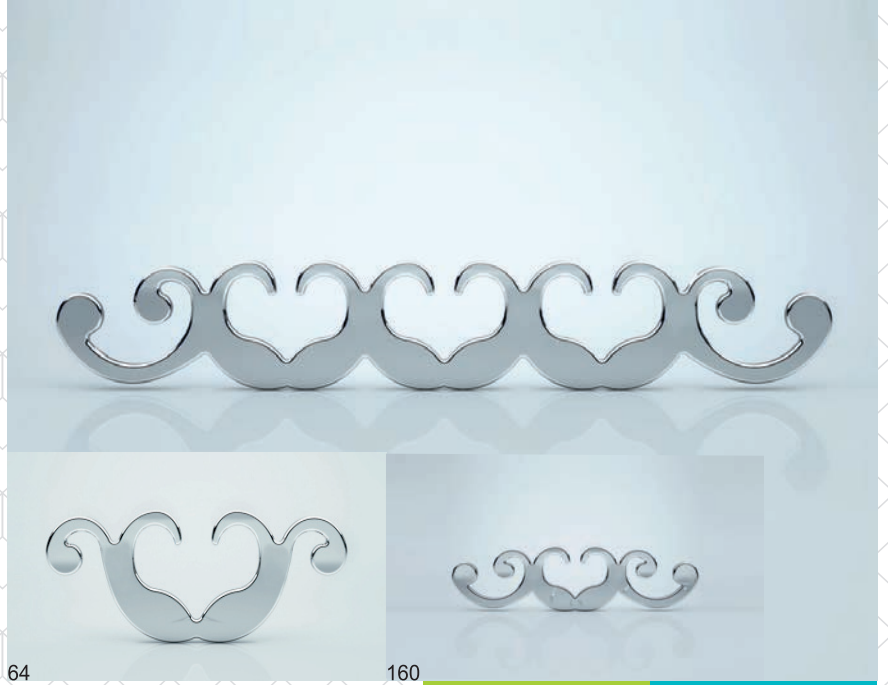
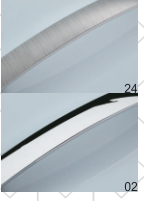

64

160

Kod
Code
K520

Maça

Ölçüler (mm)
Sizes

64
160
320

Metal Renkler
Metal Colors

24 Inox
02 Krom

Metal Renkler
Metal Colors

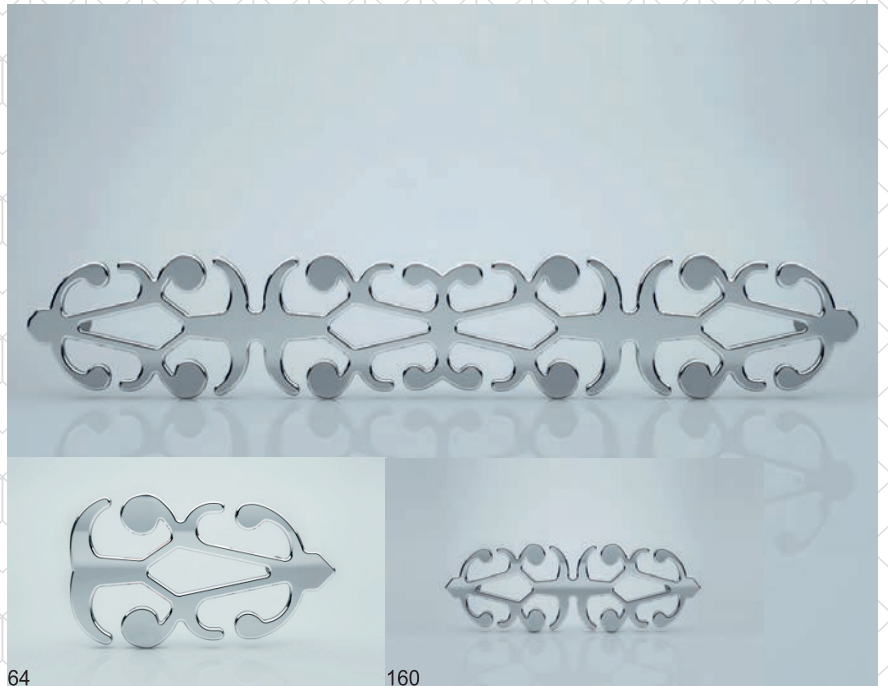
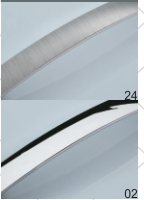

64

160

Kod
Code
K525

Rena

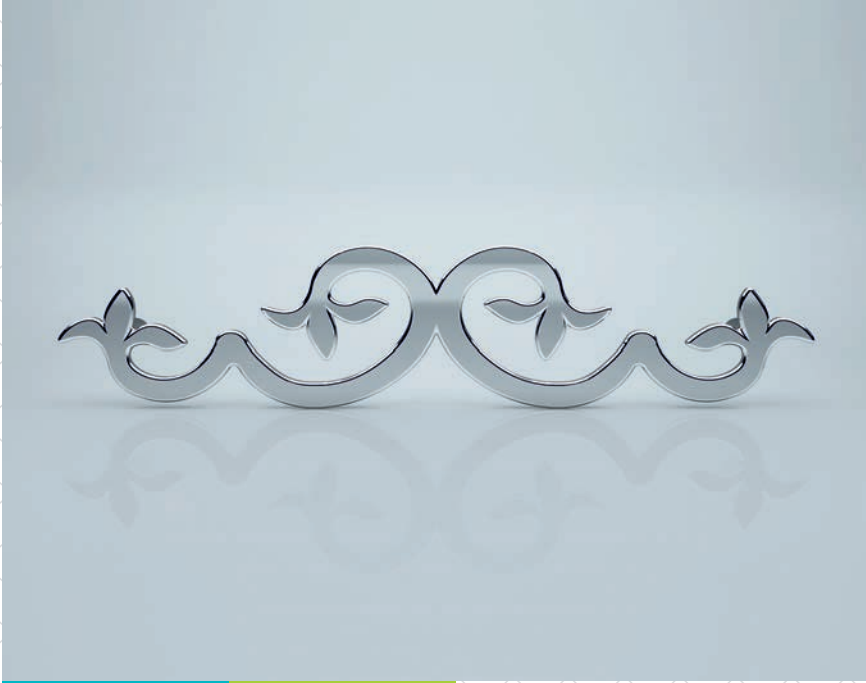

Ölçüler (mm)
Sizes

160

Metal Renkler
Metal Colors

24 İnox
02 Krom

Metal Renkler
Metal Colors



Lira

Kod
Code
K530

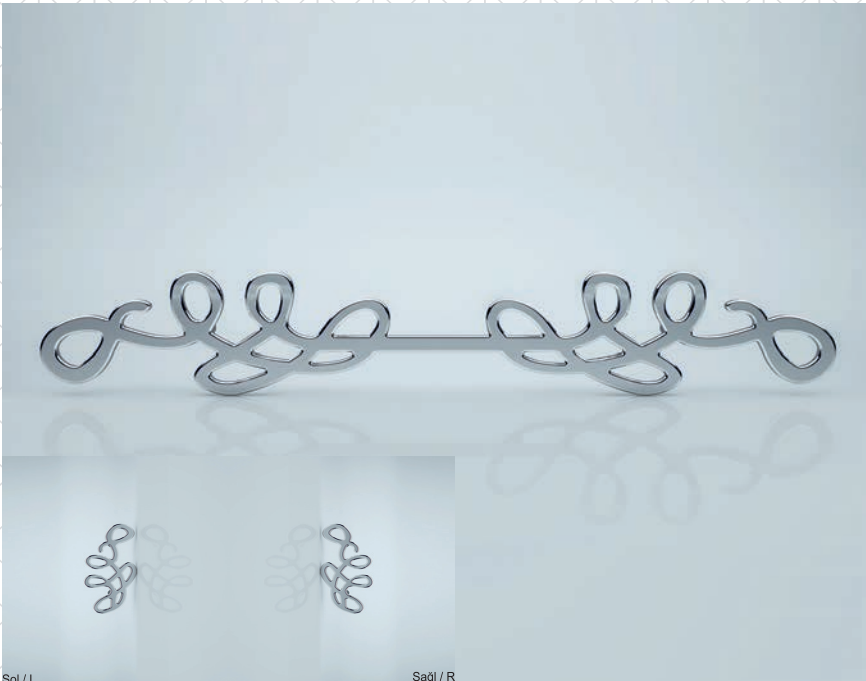

Ölçüler (mm)
Sizes

64
160

Metal Renkler
Metal Colors

24 İnox
02 Krom

Metal Renkler
Metal Colors

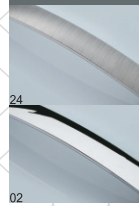

Rita

Kod
Code
K510

Ölçüler (mm)
Sizes

160
192
224
256
288
320
352
384
416

Metal Renkler
Metal Colors

02 Krom

Metal Renkler
Metal Colors



Kod
Code

SB

Sembol

Ölçüler (mm)
Sizes

160
192
224
256
288
320
352
384
416

Metal Renkler
Metal Colors

24 İnox
02 Krom

Metal Renkler
Metal Colors

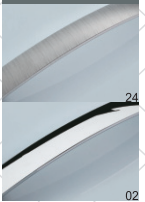

Kod
Code

TR

Tetra

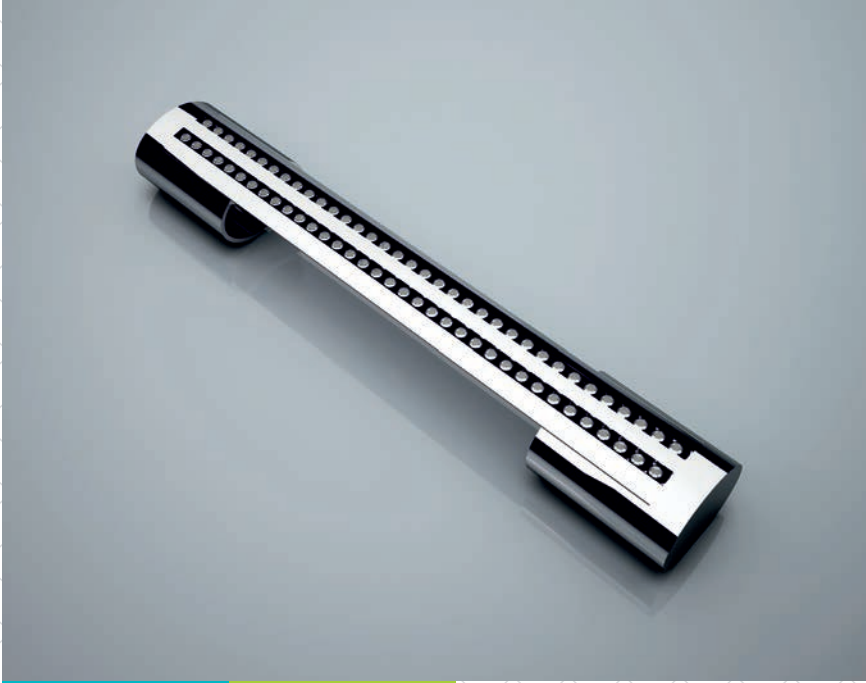

Ölçüler (mm)
Sizes

160
192
224
256
288
320
352
384
416

Metal Renkler
Metal Colors

24 İnox
02 Krom

Metal Renkler
Metal Colors



Axis

Kod
Code
AX



Ölçüler (mm)
Sizes

160
192
224
256
288
320
352
384
416

Metal Renkler
Metal Colors

24 İnox
02 Krom

Plastik Renkler
Plastic Colors

02 Krom
04 Siyah
08 Kırmızı
10 Sarı
19 FÜME
20 Beyaz

Metal Renkler
Metal Colors



Plastik Renkler / Plastic Colors

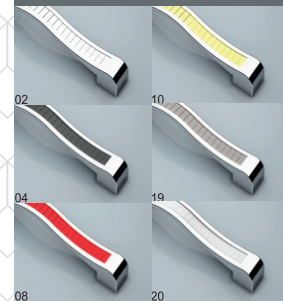

Delta

Kod
Code
DT

Ölçüler (mm)
Sizes

192
256
320

Metal Renkler
Metal Colors

24 Inox
02 Krom

Plastik Renkler
Plastic Colors

50 Kristal
55 Sarı
60 Mavi
65 Siyah
70 Kırmızı
75 Yeşil

Metal Renkler
Metal Colors

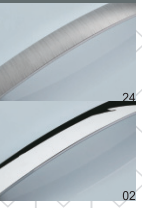

Plastik Renkler / Plastic Colors

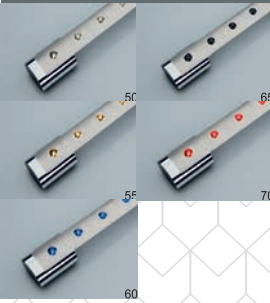

Kod
Code
RZ

Roza

Ölçüler (mm)
Sizes

192
256
320

Metal Renkler
Metal Colors

24 Inox
02 Krom

Plastik Renkler
Plastic Colors

50 Kristal
55 Sarı
60 Mavi
65 Siyah
70 Kırmızı
75 Yeşil

Metal Renkler
Metal Colors

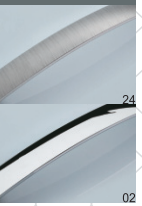

Plastik Renkler / Plastic Colors

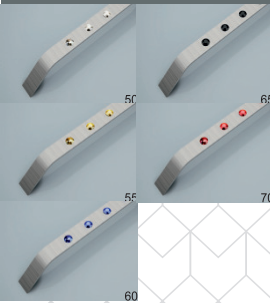

Kod
Code
RT

Rota



Ölçüler (mm)
Sizes

192
256
320

Metal Renkler
Metal Colors

24 İnox
02 Krom

Metal Renkler
Metal Colors



Penta

Kod
Code
PN



Ölçüler (mm)
Sizes

160
192
224
256
320

Metal Renkler
Metal Colors

24 İnox
02 Krom

Metal Renkler
Metal Colors

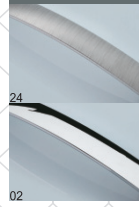

Deko

Kod
Code
DK

Ölçüler (mm)
Sizes

96
128
160
192
224
256
288
320
352
384
416

Metal Renkler
Metal Colors

24 Inox
02 Krom

Metal Renkler
Metal Colors

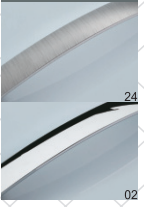

Kod
Code
LD

Lada

Ölçüler (mm)
Sizes

160
192
224
256
288
320
352
384
416

Metal Renkler
Metal Colors

24 Inox
02 Krom

Metal Renkler
Metal Colors

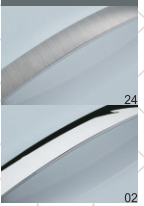

Kod
Code
MX

Maxi



Ölçüler (mm)
Sizes

160
192
224
256
288
320
352
384
416

Metal Renkler
Metal Colors

24 İnox
02 Krom

Metal Renkler
Metal Colors



Simge

Kod
Code
SM



Ölçüler (mm)
Sizes

160
192
224
256
288
320
352
384
416

Metal Renkler
Metal Colors

24 İnox
02 Krom

Metal Renkler
Metal Colors

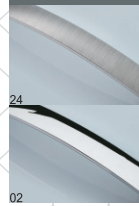

Moda

Kod
Code
MD

Ölçüler (mm)
Sizes

160
192
224
256
288
320
352
384
416

Metal Renkler
Metal Colors

24 Inox
02 Krom

Metal Renkler
Metal Colors

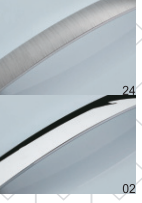

Kod
Code

İK

İkon

Ölçüler (mm)
Sizes

160
192
224
256
288
320
352
384
416

Metal Renkler
Metal Colors

24 Inox
02 Krom

Metal Renkler
Metal Colors

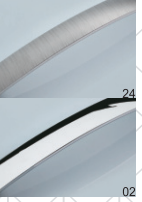

Kod
Code

ST

Stil



Ölçüler (mm)
Sizes

96
128
160
192
224
256
288
320
352
384
416
448
512

Metal Renkler
Metal Colors

02 Krom

Metal Renkler
Metal Colors



02

Marka

**Kod
Code**
MR



Ölçüler (mm)
Sizes

96
128
160
192
224
256
288
320
352
384
416
448
512

Metal Renkler
Metal Colors

02 Krom

Metal Renkler
Metal Colors



02

Gömme

**Kod
Code**
G

Ölçüler (mm)
Sizes

128
192

Metal Renkler
Metal Colors

24 Inox
02 Krom
22 Mat Krom

Plastik Renkler
Plastic Colors

02 Krom
04 Siyah
08 Kırmızı
10 Sarı
19 Füme
20 Beyaz

Metal Renkler
Metal Colors

Plastik Renkler / Plastic Colors

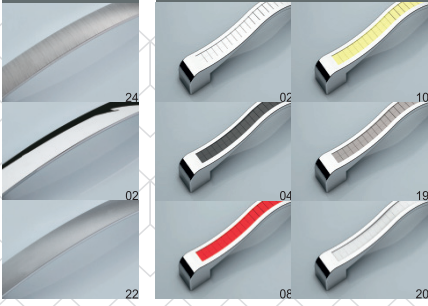

Kod
Code
K500

Te-Beta

Ölçüler (mm)
Sizes

96
128
160
192
224

Metal Renkler
Metal Colors

25 Krom Inox
24 Inox
02 Krom
22 Mat Krom
17 Saten

Metal Renkler
Metal Colors

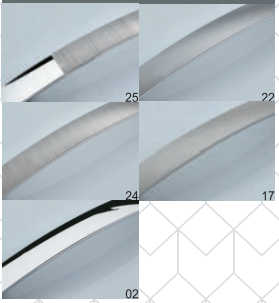

Kod
Code
K945

Nil



Ölçüler (mm)
Sizes

32

Metal Renkler
Metal Colors

24 İnox
02 Krom
22 Mat Krom
17 Saten
18 Antik Bakır
23 Antik Sarı

Plastik Renkler
Plastic Colors

02 Krom
04 Siyah
08 Kırmızı
10 Sarı
19 Füme
20 Beyaz

Metal Renkler
Metal Colors

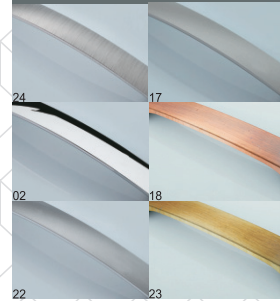

Plastik Renkler / Plastic Colors

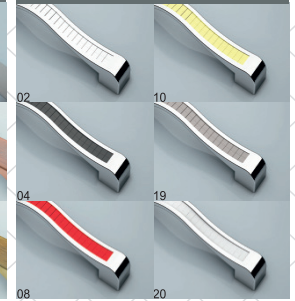

32 Te-Beta

Kod
Code
K500-32

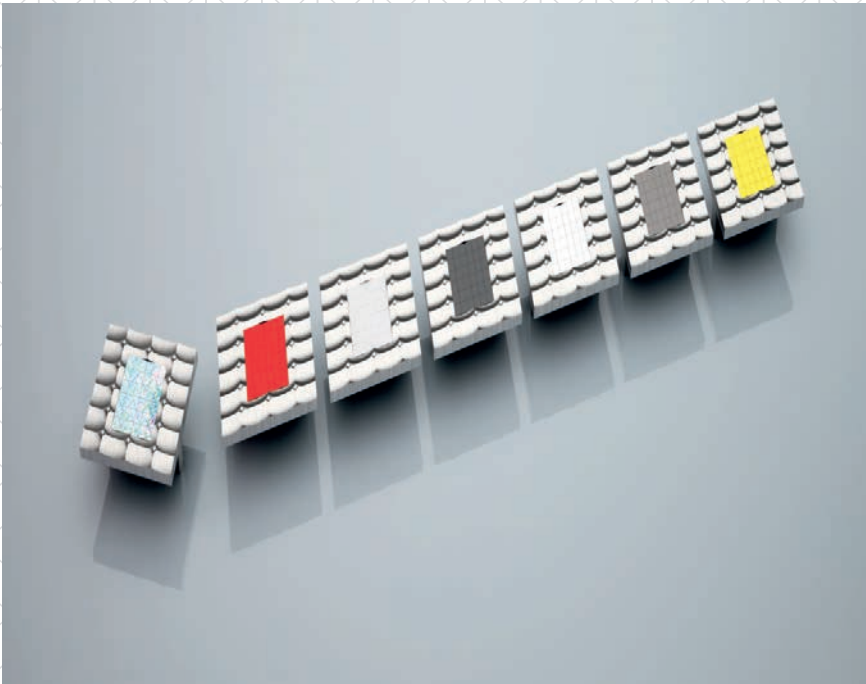

Ölçüler (mm)
Sizes

32

Metal Renkler
Metal Colors

24 İnox
02 Krom
22 Mat Krom
17 Saten
18 Antik Bakır
23 Antik Sarı

Plastik Renkler
Plastic Colors

02 Krom
04 Siyah
08 Kırmızı
10 Sarı
19 Füme
20 Beyaz

Metal Renkler
Metal Colors

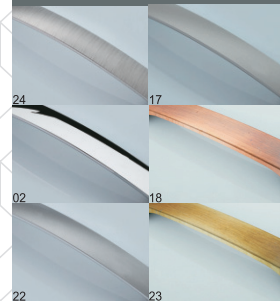

Plastik Renkler / Plastic Colors



32 Zeta

Kod
Code
ZT

Ölçüler (mm)
 Sizes

 Metal Renkler
 Metal Colors

 Plastik Renkler
 Plastic Colors

 -
 24 İnox
 02 Krom
 22 Mat Krom
 23 Antik Sarı

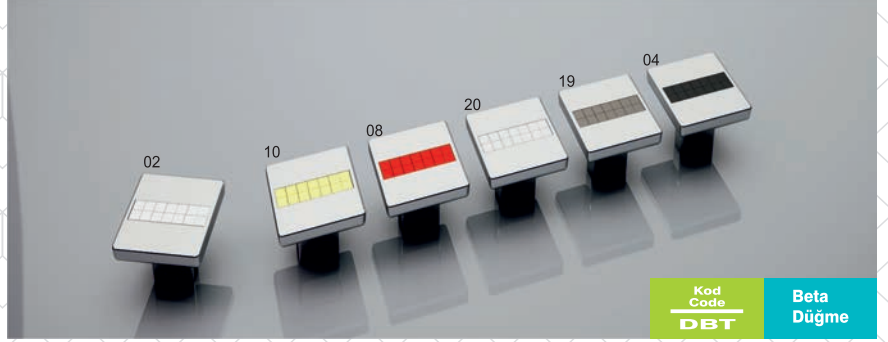
 02 Krom
 04 Siyah
 08 Kırmızı
 10 Sarı
 19 Füme
 20 Beyaz

 Kod
 Code
DBT
**Beta
 Düğme**

 Ölçüler (mm)
 Sizes

 Metal Renkler
 Metal Colors

 Plastik Renkler
 Plastic Colors

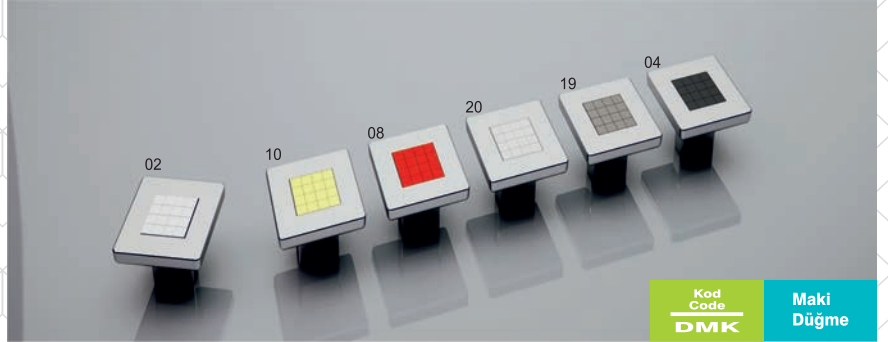
 -
 24 İnox
 02 Krom
 22 Mat Krom
 23 Antik Sarı

 02 Krom
 04 Siyah
 08 Kırmızı
 10 Sarı
 19 Füme
 20 Beyaz

 Kod
 Code
DMK
**Maki
 Düğme**

 Ölçüler (mm)
 Sizes

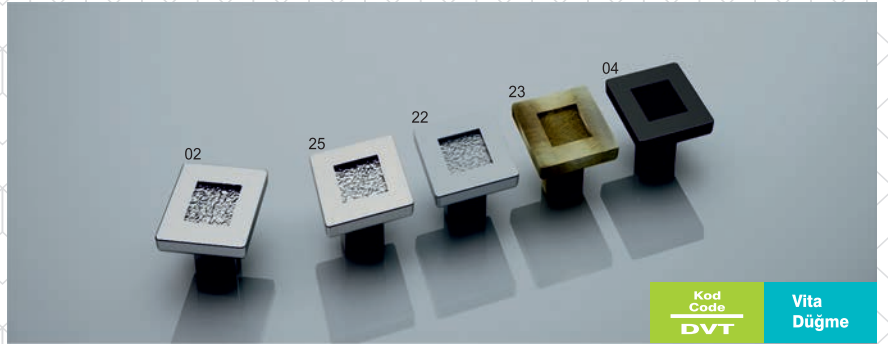
 Metal Renkler
 Metal Colors

 -
 25 Krom İnox
 02 Krom
 22 Mat Krom
 23 Antik Sarı
 04 Siyah

 Kod
 Code
DVT
**Vita
 Düğme**

 Ölçüler (mm)
 Sizes

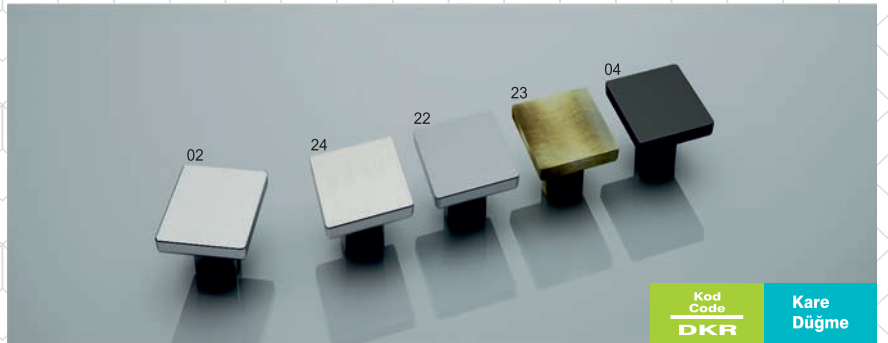
 Metal Renkler
 Metal Colors

 -
 24 İnox
 02 Krom
 22 Mat Krom
 23 Antik Sarı
 04 Siyah

 Kod
 Code
DKR
**Kare
 Düğme**

 Ölçüler (mm)
 Sizes

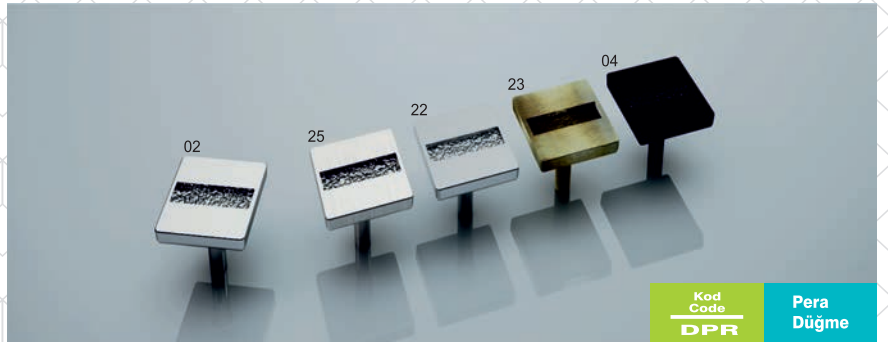
 Metal Renkler
 Metal Colors

 -
 25 Krom İnox
 02 Krom
 22 Mat Krom
 23 Antik Sarı
 04 Siyah

 Kod
 Code
DPR
**Pera
 Düğme**

**Vita
Portmanto**

Kod
Code
P805



Ölçüler (mm)
Sizes

Metal Renkler
Metal Colors

- 25 Krom İnox
- 02 Krom
- 22 Mat Krom
- 23 Antik Sarı
- 04 Siyah

**Vita
Askı**

Kod
Code
A805



Ölçüler (mm)
Sizes

Metal Renkler
Metal Colors

- 25 Krom İnox
- 02 Krom
- 22 Mat Krom
- 23 Antik Sarı
- 04 Siyah

**Beta
Portmanto**

Kod
Code
PBT

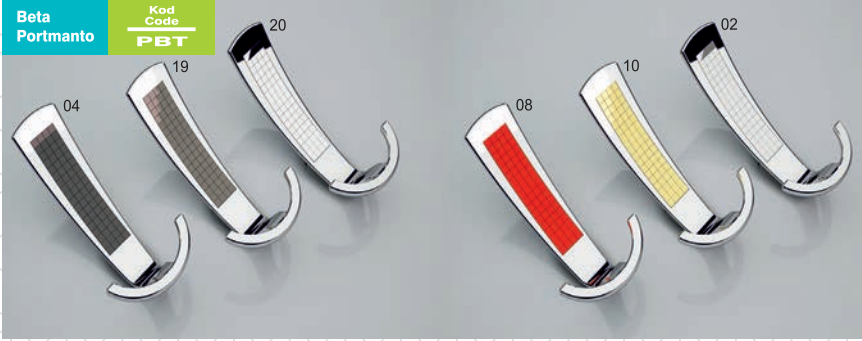

Ölçüler (mm)
Sizes

Metal Renkler
Metal Colors

Plastik Renkler
Plastic Colors

- 24 İnox
- 02 Krom
- 22 Mat Krom
- 23 Antik Sarı
- 02 Krom
- 04 Siyah
- 08 Kırmızı
- 10 Sarı
- 19 Füme
- 20 Beyaz

**Beta
Askı**

Kod
Code
ABT

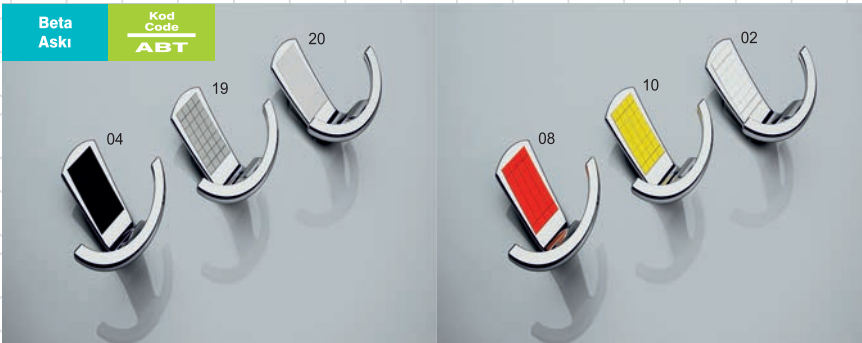

Ölçüler (mm)
Sizes

Metal Renkler
Metal Colors

Plastik Renkler
Plastic Colors

- 24 İnox
- 02 Krom
- 22 Mat Krom
- 23 Antik Sarı
- 02 Krom
- 04 Siyah
- 08 Kırmızı
- 10 Sarı
- 19 Füme
- 20 Beyaz

**Te-Beta
Portmanto**

Kod
Code
P500



Ölçüler (mm)
Sizes

Metal Renkler
Metal Colors

Plastik Renkler
Plastic Colors

- 24 İnox
- 02 Krom
- 22 Mat Krom
- 23 Antik Sarı
- 02 Krom
- 04 Siyah
- 08 Kırmızı
- 10 Sarı
- 19 Füme
- 20 Beyaz

Ölçüler (mm)
Sizes

Metal Renkler
Metal Colors

-
24 Inox
02 Krom
22 Mat Krom
18 Antik Bakır
23 Antik Sarı



Kod
Code
PRS

Reis
Portmanto

Ölçüler (mm)
Sizes

Metal Renkler
Metal Colors

-
24 Inox
02 Krom
22 Mat Krom
18 Antik Bakır
23 Antik Sarı



Kod
Code
ARS

Reis
Askı

Ölçüler (mm)
Sizes

Metal Renkler
Metal Colors

-
24 Inox
02 Krom
22 Mat Krom
18 Antik Bakır
23 Antik Sarı



Kod
Code
PRD

Redif
Portmanto

Ölçüler (mm)
Sizes

Metal Renkler
Metal Colors

-
24 Inox
02 Krom
22 Mat Krom
18 Antik Bakır
23 Antik Sarı



Kod
Code
ARD

Redif
Askı

Ölçüler (mm)
Sizes

Metal Renkler
Metal Colors

Plastik Renkler
Plastic Colors

-
24 Inox
02 Krom
22 Mat Krom
23 Antik Sarı
02 Krom
04 Siyah
08 Kırmızı
10 Sarı
19 Füme
20 Beyaz



Kod
Code
A500

Te-Beta
Askı

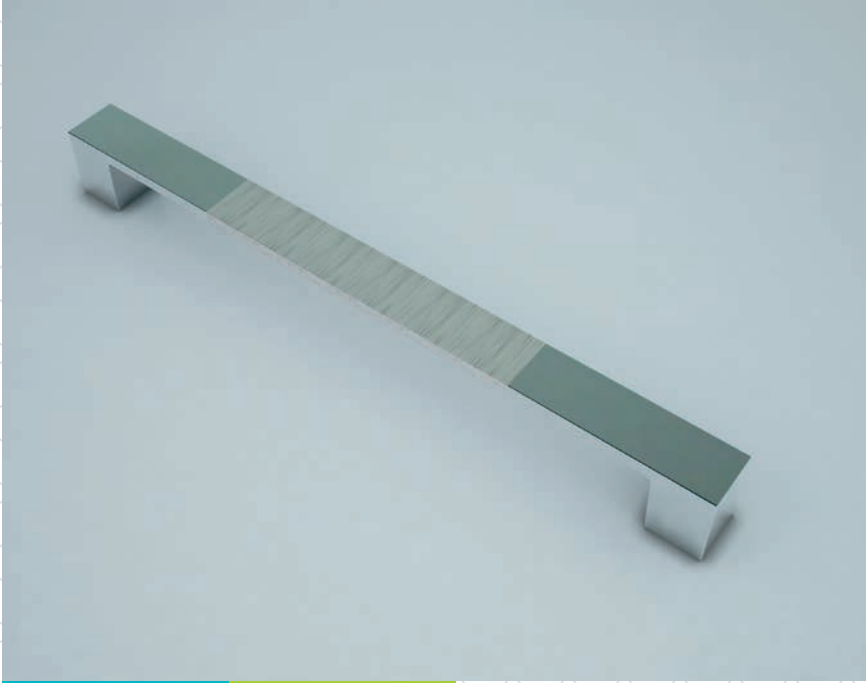

Ölçüler (mm)
Sizes

128
160
192
224
256

Metal Renkler
Metal Colors

25 Krom İnox
24 İnox
02 Krom
22 Mat Krom
17 Saten

Metal Renkler
Metal Colors

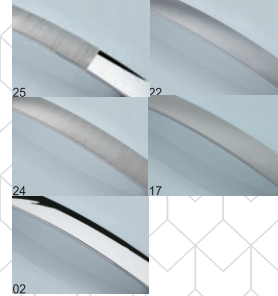

Te-Kare

Kod
Code
TK



Ölçüler (mm)
Sizes

128
160
192
224
256

Metal Renkler
Metal Colors

25 Krom İnox
02 Krom
22 Mat Krom
17 Saten

Metal Renkler
Metal Colors

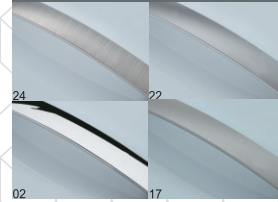

Kare-Te

Kod
Code
KRT

Ölçüler (mm)
Sizes

128
224

Metal Renkler
Metal Colors

25 Krom Inox
24 Inox
02 Krom
22 Mat Krom
17 Saten

Metal Renkler
Metal Colors

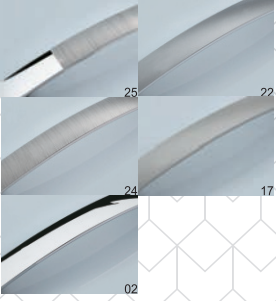

Kod
Code
K100

Yay

Ölçüler (mm)
Sizes

128
160
192

Metal Renkler
Metal Colors

25 Krom Inox
24 Inox
02 Krom
22 Mat Krom
17 Saten

Metal Renkler
Metal Colors

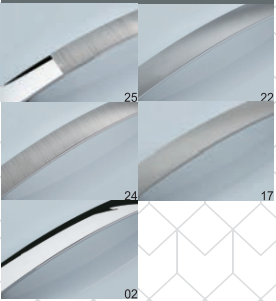

Kod
Code
K890

Armi



Ölçüler (mm)
Sizes

128
160
192
224

Metal Renkler
Metal Colors

25 Krom İnox
24 İnox
02 Krom
22 Mat Krom
17 Saten

Metal Renkler
Metal Colors

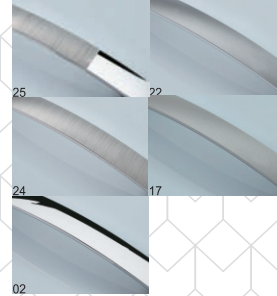

Aras

Kod
Code
K800



Ölçüler (mm)
Sizes

128
160
192
224

Metal Renkler
Metal Colors

25 Krom İnox
02 Krom
22 Mat Krom
17 Saten
18 Antik Bakır
23 Antik Sarı

Metal Renkler
Metal Colors

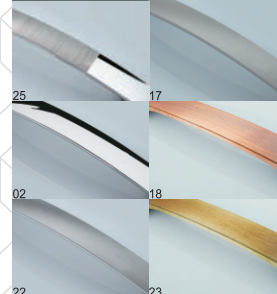

Haliç

Kod
Code
K805

Ölçüler (mm)
Sizes

96
128
160
192
224

Metal Renkler
Metal Colors

25 Krom Inox
24 Inox
02 Krom
22 Mat Krom
17 Saten

Metal Renkler
Metal Colors

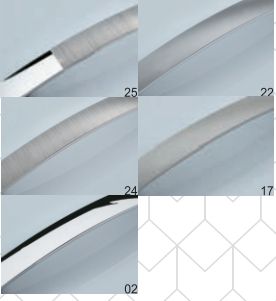

Kod
Code
K785

Hilal

Ölçüler (mm)
Sizes

96
128
160
192
224

Metal Renkler
Metal Colors

25 Krom Inox
02 Krom
22 Mat Krom
17 Saten
18 Antik Bakır
23 Antik Sarı

Metal Renkler
Metal Colors

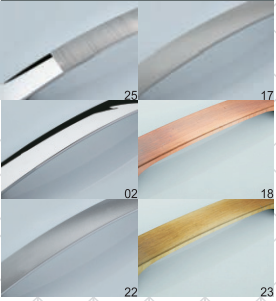

Kod
Code
K790

Kamer



Ölçüler (mm)
Sizes

128
160
192
224

Metal Renkler
Metal Colors

25 Krom İnox
24 İnox
02 Krom
22 Mat Krom
17 Saten

Metal Renkler
Metal Colors

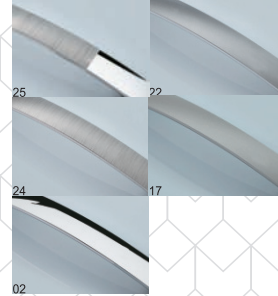

Eta

Kod
Code
ET



Ölçüler (mm)
Sizes

128
160
192
224

Metal Renkler
Metal Colors

24 İnox
02 Krom
22 Mat Krom
17 Saten

Metal Renkler
Metal Colors

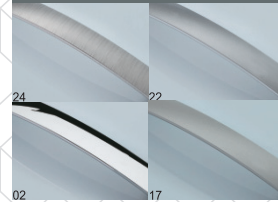

Lena

Kod
Code
LN

Ölçüler (mm)
Sizes

128
160
192
224
256

Metal Renkler
Metal Colors

25 Krom Inox
24 Inox
02 Krom
22 Mat Krom
17 Saten

Metal Renkler
Metal Colors

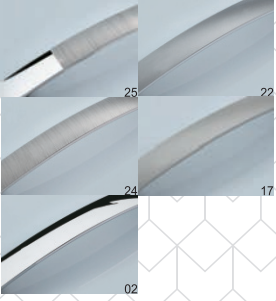

Kod
Code

BK

Beko

Ölçüler (mm)
Sizes

128
160
192
224
256

Metal Renkler
Metal Colors

25 Krom Inox
02 Krom
22 Mat Krom
17 Saten

Metal Renkler
Metal Colors

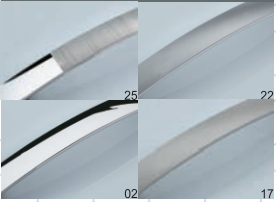

Kod
Code

NT

Nata



Ölçüler (mm)
Sizes

128
160

Metal Renkler
Metal Colors

25 Krom İnox
24 İnox
02 Krom
22 Mat Krom
17 Saten

Metal Renkler
Metal Colors

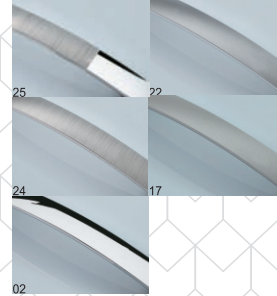

Narin

Kod
Code
K905



Ölçüler (mm)
Sizes

128
160
192

Metal Renkler
Metal Colors

25 Krom İnox
24 İnox
02 Krom
22 Mat Krom
17 Saten

Metal Renkler
Metal Colors

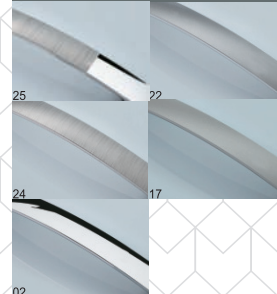

Ayaz

Kod
Code
K895

Ölçüler (mm)
Sizes

96
128
160

Metal Renkler
Metal Colors

25 Krom İnox
24 İnox
02 Krom
22 Mat Krom
17 Saten

Metal Renkler
Metal Colors

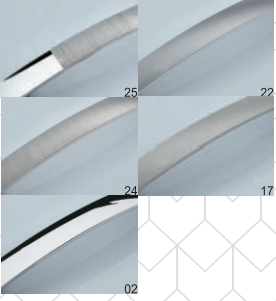

Kod
Code
U

U Kulp

Ölçüler (mm)
Sizes

96
128
160

Metal Renkler
Metal Colors

25 Krom İnox
24 İnox
02 Krom
22 Mat Krom
17 Saten

Metal Renkler
Metal Colors

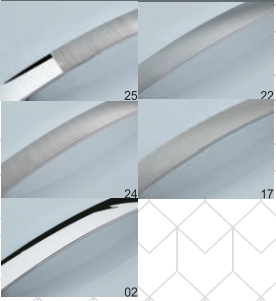

Kod
Code
T

T Kulp



Ölçüler (mm)
Sizes

160

Metal Renkler
Metal Colors

25 Krom İnox
24 İnox
02 Krom
22 Mat Krom
17 Saten

Metal Renkler
Metal Colors

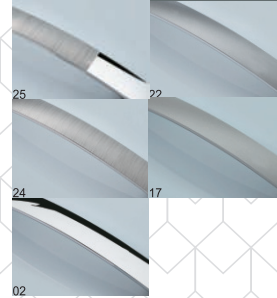

Joker

Kod
Code
K915

E Kulp

Kod
Code
E

Ölçüler (mm)
Sizes

128

Metal Renkler
Metal Colors

25 Krom Inox
24 Inox
02 Krom
22 Mat Krom
17 Saten
18 Antik Bakır
23 Antik Sarı

Metal Renkler
Metal Colors

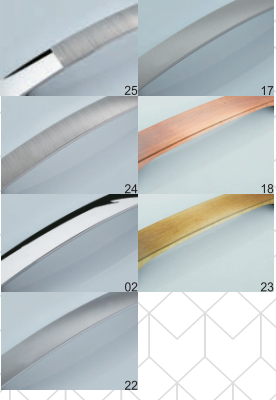

Kod
Code
K745

Arit

Ölçüler (mm)
Sizes

128

Metal Renkler
Metal Colors

25 Krom Inox
02 Krom
22 Mat Krom
17 Saten
18 Antik Bakır
23 Antik Sarı

Metal Renkler
Metal Colors

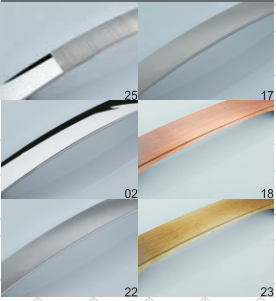

Kod
Code
İST

İstanbul



Ölçüler (mm)
Sizes

128
224

Metal Renkler
Metal Colors

25 Krom İnox
24 İnox
02 Krom
22 Mat Krom
17 Saten

Metal Renkler
Metal Colors

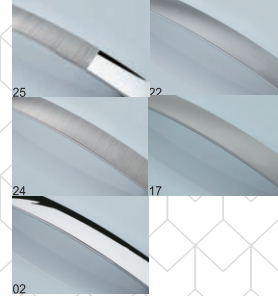

Akasya

Kod
Code
AK



Ölçüler (mm)
Sizes

128
224

Metal Renkler
Metal Colors

25 Krom İnox
02 Krom
22 Mat Krom
17 Saten
18 Antik Bakır
23 Antik Sarı

Metal Renkler
Metal Colors

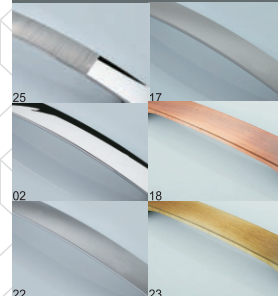

Fiyaka

Kod
Code
FK

Ölçüler (mm)
Sizes

160
256

Metal Renkler
Metal Colors

25 Krom Inox
24 Inox
02 Krom
22 Mat Krom
17 Saten

Metal Renkler
Metal Colors

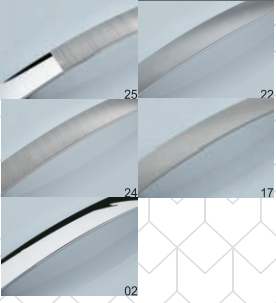

Kod
Code

MT

Meta

Ölçüler (mm)
Sizes

160
256

Metal Renkler
Metal Colors

25 Krom Inox
02 Krom
22 Mat Krom
17 Saten

Metal Renkler
Metal Colors

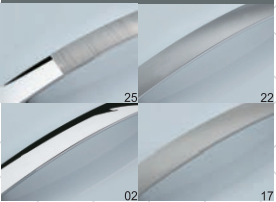

Kod
Code

VT

Vita



Ölçüler (mm)
Sizes

96
128

Metal Renkler
Metal Colors

25 Krom İnox
24 İnox
02 Krom
22 Mat Krom
17 Saten
18 Antik Bakır
23 Antik Sarı

Metal Renkler
Metal Colors

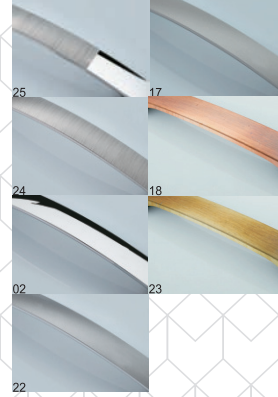

Okey

Kod
Code
K920



Ölçüler (mm)
Sizes

128
224

Metal Renkler
Metal Colors

25 Krom İnox
24 İnox
02 Krom
22 Mat Krom
17 Saten

Metal Renkler
Metal Colors

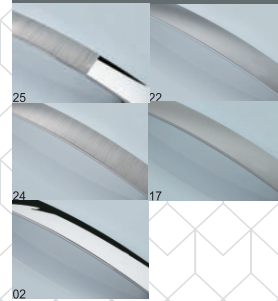

Pera

Kod
Code
PR

Ölçüler (mm)
Sizes

128

Metal Renkler
Metal Colors

25 Krom Inox
24 Inox
02 Krom
22 Mat Krom
17 Saten

Metal Renkler
Metal Colors

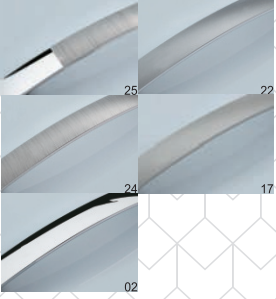

Kod
Code
K775

Gama

Ölçüler (mm)
Sizes

96
128

Metal Renkler
Metal Colors

24 Inox
02 Krom
22 Mat Krom
17 Saten
23 Antik Sarı

Metal Renkler
Metal Colors

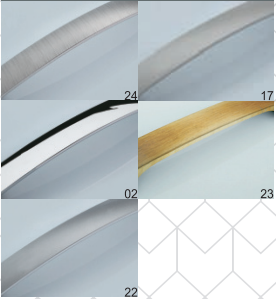

Kod
Code
K840

Artis



Ölçüler (mm)
Sizes

128

Metal Renkler
Metal Colors

25 Krom İnox
24 İnox
02 Krom
22 Mat Krom
17 Saten

Metal Renkler
Metal Colors

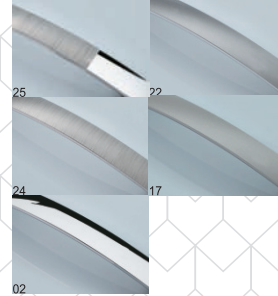

Kelebek

Kod
Code
K750



Ölçüler (mm)
Sizes

128

Metal Renkler
Metal Colors

24 İnox
02 Krom
22 Mat Krom
17 Saten
18 Antik Bakır
23 Antik Sarı

Metal Renkler
Metal Colors

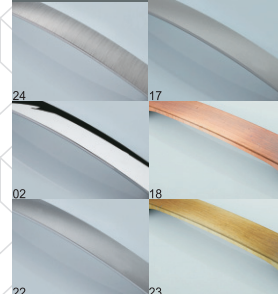

Arda

Kod
Code
K860

Ölçüler (mm)
Sizes

128

Metal Renkler
Metal Colors

25 Krom Inox
24 Inox
02 Krom
22 Mat Krom
17 Saten

Metal Renkler
Metal Colors

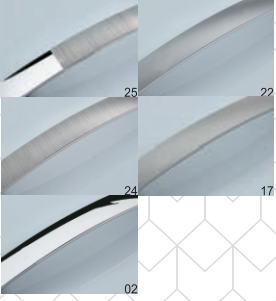

Kod
Code
K660

Ayaklı Yunus

Ölçüler (mm)
Sizes

96
128
160

Metal Renkler
Metal Colors

25 Krom Inox
24 Inox
02 Krom
22 Mat Krom
17 Saten

Metal Renkler
Metal Colors

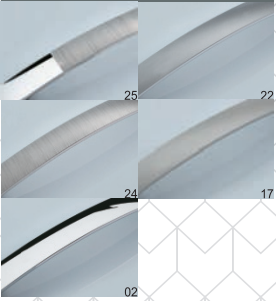

Kod
Code
K825

Lagün



Ölçüler (mm)
Sizes

128

Metal Renkler
Metal Colors

25 Krom İnox
24 İnox
02 Krom
22 Mat Krom
17 Saten

Metal Renkler
Metal Colors

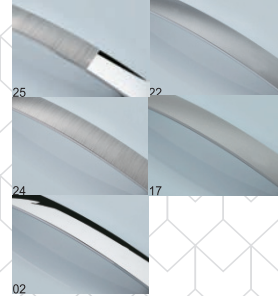

Logo

Kod
Code
K780



Ölçüler (mm)
Sizes

96
128

Metal Renkler
Metal Colors

25 Krom İnox
24 İnox
02 Krom
22 Mat Krom
17 Saten

Metal Renkler
Metal Colors

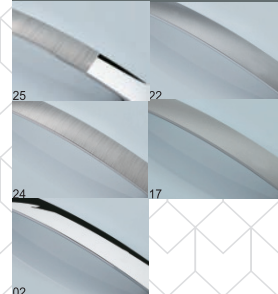

Yatay

Kod
Code
K600

Ölçüler (mm)
Sizes

Metal Renkler
Metal Colors

32
64
96

02 Krom - 22 Mat Krom

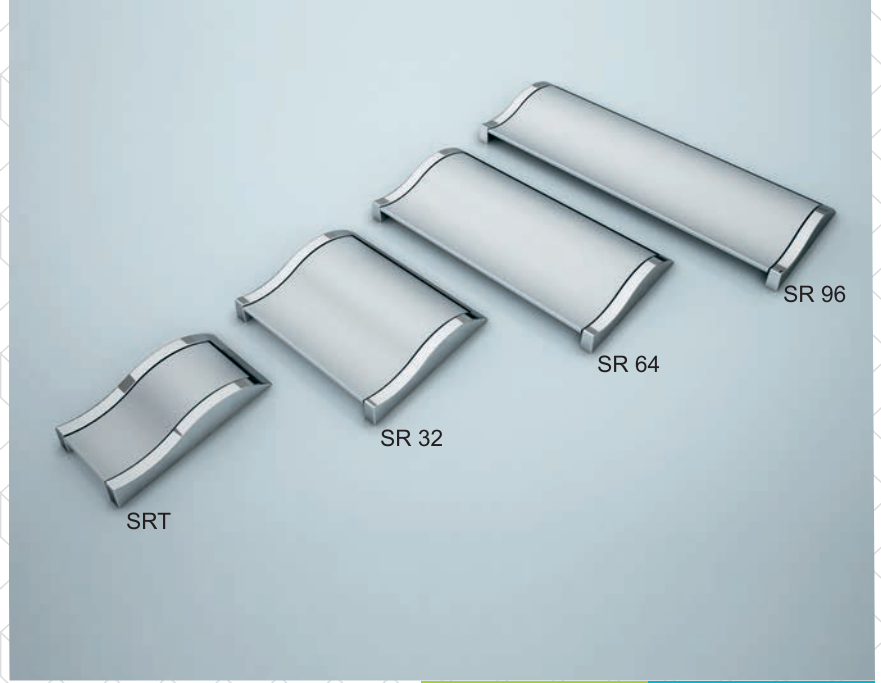

Kod
Code
SR

Sera

Ölçüler (mm)
Sizes

Metal Renkler
Metal Colors

96
128

25 Krom Inox
24 Inox
02 Krom
22 Mat Krom
17 Saten



Kod
Code
K250

Ayıklı Noktalı

Metal Renkler
Metal Colors

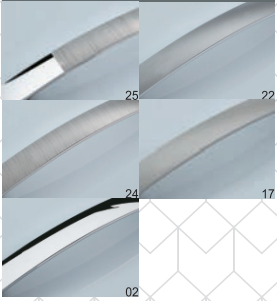



Ölçüler (mm)
Sizes

128
160

Metal Renkler
Metal Colors

25 Krom İnox
24 İnox
02 Krom
22 Mat Krom
17 Saten

Metal Renkler
Metal Colors

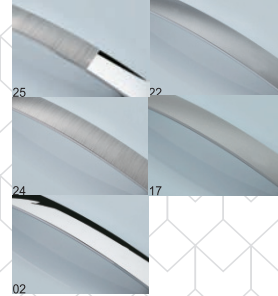

Balina

Kod
Code
K770

Venüs

Kod
Code
K740

Ölçüler (mm)
Sizes

128

Metal Renkler
Metal Colors

25 Krom İnox
24 İnox
02 Krom
22 Mat Krom
17 Saten

Metal Renkler
Metal Colors

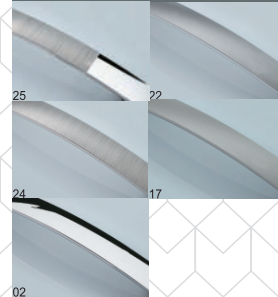

Ölçüler (mm)
Sizes

96
128
224

Metal Renkler
Metal Colors

24 Inox
02 Krom
22 Mat Krom
17 Saten
18 Antik Bakır
23 Antik Sarı

Metal Renkler
Metal Colors

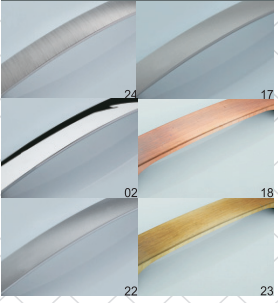

Kod
Code
K605

Petek

Ölçüler (mm)
Sizes

128
160

Metal Renkler
Metal Colors

24 Inox
02 Krom
22 Mat Krom
17 Saten

Metal Renkler
Metal Colors

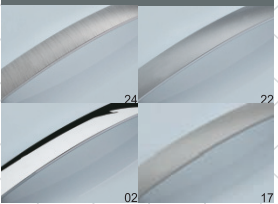

Kod
Code
K885

M Kulp



Ölçüler (mm)
Sizes

192

Metal Renkler
Metal Colors

24 İnox
02 Krom
22 Mat Krom
17 Saten

Metal Renkler
Metal Colors

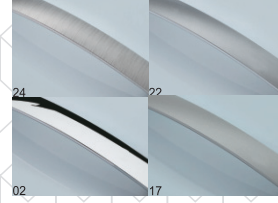

Cemre

Kod
Code
K910



Ölçüler (mm)
Sizes

160

Metal Renkler
Metal Colors

24 İnox
02 Krom
22 Mat Krom
17 Saten

Metal Renkler
Metal Colors

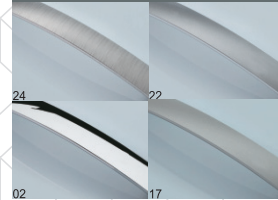

Çekme

Kod
Code
CK

Ölçüler (mm)
Sizes

64
96
128

Metal Renkler
Metal Colors

25 Krom Inox
24 Inox
02 Krom
22 Mat Krom
17 Saten
18 Antik Bakır
23 Antik Sarı

Metal Renkler
Metal Colors

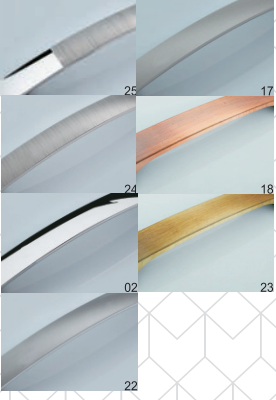

Kod
Code
K470

Antik

Ölçüler (mm)
Sizes

96

Metal Renkler
Metal Colors

24 Inox
02 Krom
22 Mat Krom
17 Saten

Metal Renkler
Metal Colors

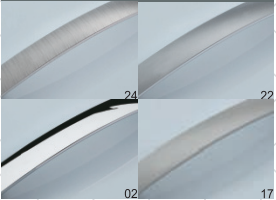

Kod
Code
K460

Aral



Ölçüler (mm)
Sizes

128

Metal Renkler
Metal Colors

25 Krom İnox
02 Krom
22 Mat Krom
17 Saten

Metal Renkler
Metal Colors

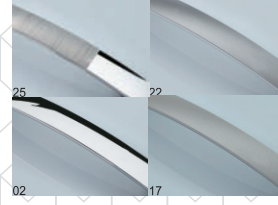

Antik Yay

Kod
Code
K815



Ölçüler (mm)
Sizes

128

Metal Renkler
Metal Colors

25 Krom İnox
24 İnox
02 Krom
22 Mat Krom
17 Saten
18 Antik Bakır
23 Antik Sarı

Metal Renkler
Metal Colors

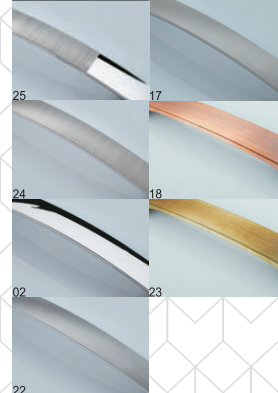

Antika

Kod
Code
K810

Ölçüler (mm)
Sizes

128

Metal Renkler
Metal Colors

25 Krom Inox
24 Inox
02 Krom
22 Mat Krom
17 Saten
18 Antik Bakır
23 Antik Sarı

Metal Renkler
Metal Colors

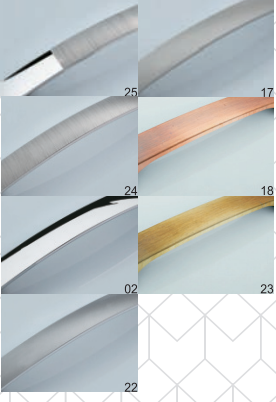

Kod
Code
K795

Antik V

Ölçüler (mm)
Sizes

96
128

Metal Renkler
Metal Colors

25 Krom Inox
24 Inox
02 Krom
22 Mat Krom
17 Saten

Metal Renkler
Metal Colors

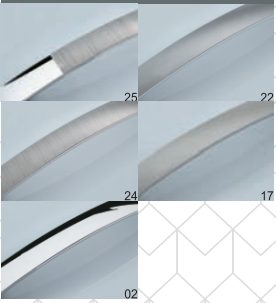

Kod
Code
K375

Ayaklı Düz



Ölçüler (mm)
Sizes

128

Metal Renkler
Metal Colors

02 Krom
22 Mat Krom

Plastik Renkler
Plastic Colors

01 Akça
02 Kayın
03 Armut
04 Kiraz
05 Maun
06 Venge
07 Ceviz
08 Kırmızı

Metal Renkler
Metal Colors

Metal Renkler
Metal Colors

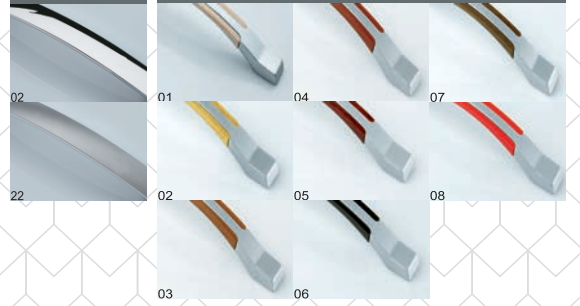

Ata

Kod
Code
K830



Ölçüler (mm)
Sizes

128

Metal Renkler
Metal Colors

02 Krom
22 Mat Krom

Plastik Renkler
Plastic Colors

09 Yeşil
10 Sarı
11 Lila
12 Turuncu
13 Mavi
14 Siyah
15 Beyaz
16 Pembe

Metal Renkler
Metal Colors

Metal Renkler
Metal Colors

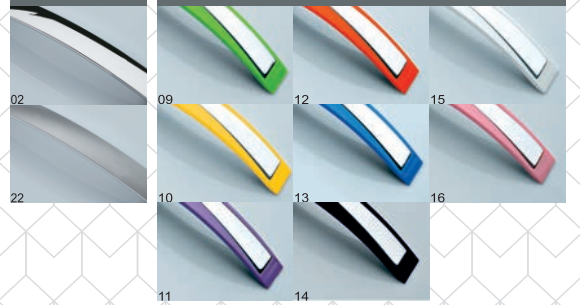

Yaka

Kod
Code
K935

Ölçüler (mm)
Sizes

96
128

Metal Renkler
Metal Colors

02 Krom
22 Mat Krom
17 Saten
18 Antik Bakır
23 Antik Sarı

Metal Renkler
Metal Colors

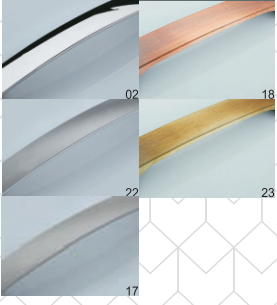

Kod
Code
K360

Işık

Ölçüler (mm)
Sizes

96
128

Metal Renkler
Metal Colors

02 Krom
22 Mat Krom
17 Saten

Metal Renkler
Metal Colors

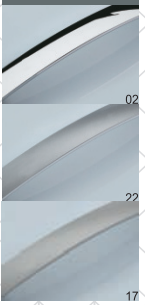

Kod
Code
K415

Noktalı Yay



Ölçüler (mm)
Sizes

64
96
128

Metal Renkler
Metal Colors

02 Krom
22 Mat Krom
17 Saten
04 Siyah

Metal Renkler
Metal Colors

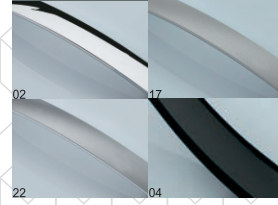

Kalın Yay

Kod
Code
K120



Ölçüler (mm)
Sizes

96
128

Metal Renkler
Metal Colors

02 Krom
22 Mat Krom
17 Saten

Metal Renkler
Metal Colors

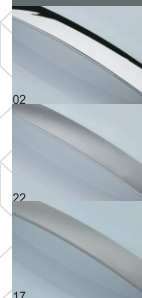

Ayaklı S

Kod
Code
K180

Ölçüler (mm)
Sizes

96
128

Metal Renkler
Metal Colors

25 Krom İnox
24 İnox
02 Krom
22 Mat Krom
17 Saten
18 Antik Bakır
23 Antik Sarı

Metal Renkler
Metal Colors

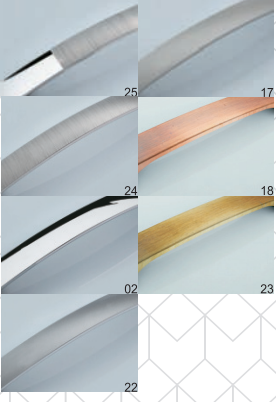

Kod
Code
K405

K405

Ölçüler (mm)
Sizes

96
128

Metal Renkler
Metal Colors

02 Krom
22 Mat Krom
17 Saten

Metal Renkler
Metal Colors

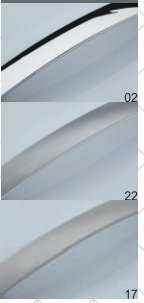

Kod
Code
K365

K365



Ölçüler (mm)
Sizes

96

Metal Renkler
Metal Colors

02 Krom
22 Mat Krom
17 Saten

Metal Renkler
Metal Colors



Yeni Noktalı

Kod
Code
M300



Ölçüler (mm)
Sizes

96

Metal Renkler
Metal Colors

02 Krom
22 Mat Krom
17 Saten

Metal Renkler
Metal Colors



E.Ayaklı Noktalı

Kod
Code
M115

Ölçüler (mm)
Sizes

96

Metal Renkler
Metal Colors

02 Krom
22 Mat Krom
17 Saten

Metal Renkler
Metal Colors

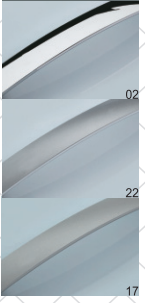

Kod
Code
M110

Kare Noktalı

Ölçüler (mm)
Sizes

96

Metal Renkler
Metal Colors

02 Krom
22 Mat Krom
17 Saten

Metal Renkler
Metal Colors

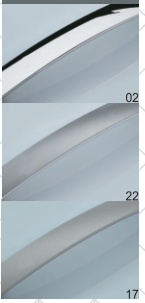

Kod
Code
M150

S Kulp



Ölçüler (mm)
Sizes

96

Metal Renkler
Metal Colors

02 Krom
22 Mat Krom
17 Saten

Metal Renkler
Metal Colors



Efe

Kod
Code
K305



Ölçüler (mm)
Sizes

96

Metal Renkler
Metal Colors

02 Krom
22 Mat Krom
17 Saten

Metal Renkler
Metal Colors



Yeni Efe

Kod
Code
K385

Ölçüler (mm)
Sizes

96

Metal Renkler
Metal Colors

02 Krom
22 Mat Krom
17 Saten

Metal Renkler
Metal Colors

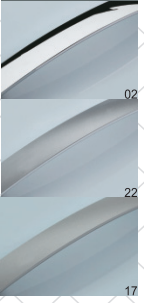

Kod
Code
M240

M.Noktalı

Ölçüler (mm)
Sizes

96

Metal Renkler
Metal Colors

02 Krom
22 Mat Krom
17 Saten

Metal Renkler
Metal Colors

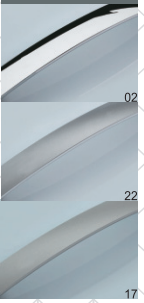

Kod
Code
K265

M.Çiçekli



Ölçüler (mm)
Sizes

96

Metal Renkler
Metal Colors

02 Krom
22 Mat Krom
17 Saten

Metal Renkler
Metal Colors



Düz

Kod
Code
K275



Ölçüler (mm)
Sizes

96

Metal Renkler
Metal Colors

02 Krom
22 Mat Krom
17 Saten

Metal Renkler
Metal Colors



Elif

Kod
Code
M145

Ölçüler (mm)
Sizes

96

Metal Renkler
Metal Colors

02 Krom
22 Mat Krom
17 Saten

Metal Renkler
Metal Colors

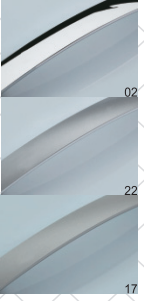

Kod
Code
M155

İnce Yay

Ölçüler (mm)
Sizes

96

Metal Renkler
Metal Colors

02 Krom
22 Mat Krom
17 Saten

Metal Renkler
Metal Colors

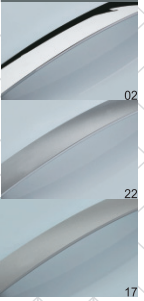

Kod
Code
M135

Fil Ayağı



Ölçüler (mm)
Sizes

96

Metal Renkler
Metal Colors

02 Krom
22 Mat Krom
17 Saten
18 Antik Bakır
23 Antik Sarı

Metal Renkler
Metal Colors

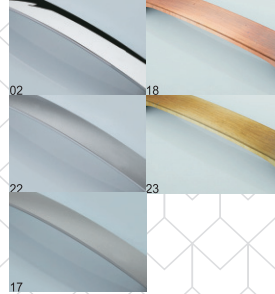

Ayyıldız

Kod
Code
K650



Ölçüler (mm)
Sizes

96

Metal Renkler
Metal Colors

02 Krom
22 Mat Krom
17 Saten
18 Antik Bakır
23 Antik Sarı

Metal Renkler
Metal Colors

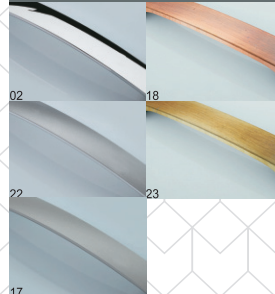

Yonca

Kod
Code
M170

Ölçüler (mm)
Sizes

96

Metal Renkler
Metal Colors

25 Krom İnox

Metal Renkler
Metal Colors



25



Kod
Code
N335

Yeni Ege

Ölçüler (mm)
Sizes

96
128

Metal Renkler
Metal Colors

25 Krom İnox

Metal Renkler
Metal Colors



25



Kod
Code
K850

Lades



Ölçüler (mm)
Sizes

96
128
160

Metal Renkler
Metal Colors

25 Krom İnox

Metal Renkler
Metal Colors



25

Yeni Yatay

Kod
Code
N590



Ölçüler (mm)
Sizes

128
160
192

Metal Renkler
Metal Colors

25 Krom İnox

Metal Renkler
Metal Colors



25

Ekol

Kod
Code
K900

Ölçüler (mm)
Sizes

96
128

Metal Renkler
Metal Colors

25 Krom Inox
24 Inox
02 Krom
22 Mat Krom
17 Saten

Metal Renkler
Metal Colors

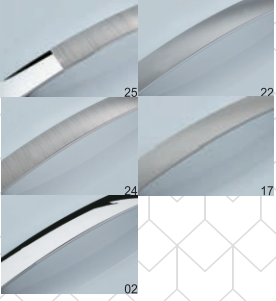

Kod
Code
K420

Yeni Yunus

Ölçüler (mm)
Sizes

96

Metal Renkler
Metal Colors

02 Krom
22 Mat Krom
17 Saten

Metal Renkler
Metal Colors

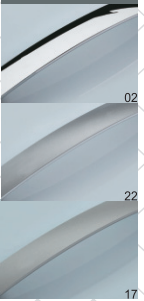

Kod
Code
K190

Yeni Yay

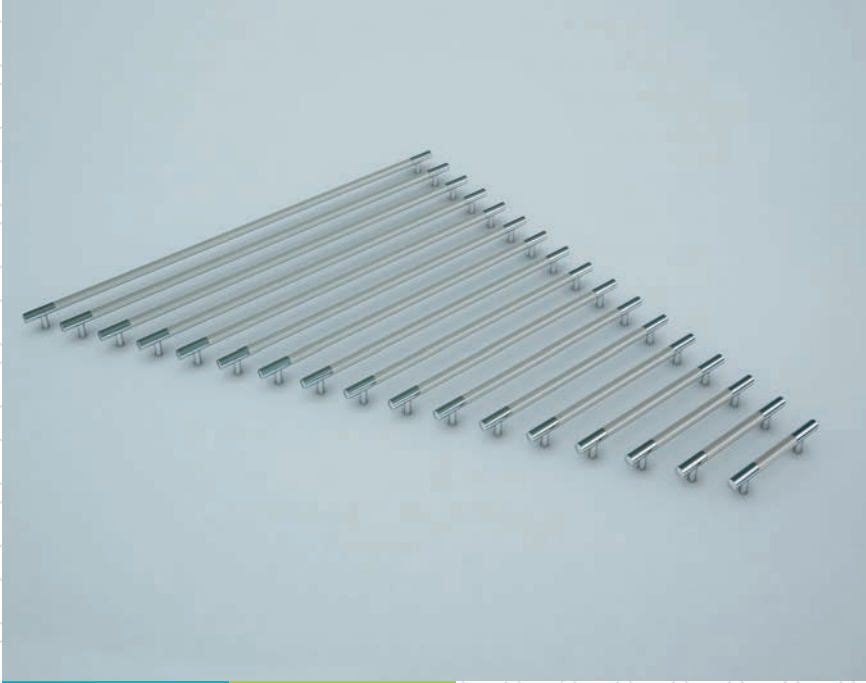

Ölçüler (mm)
Sizes

96
128
160
192
224
256
288
320
352

Metal Renkler
Metal Colors

02 Krom

Metal Renkler
Metal Colors



AL Kulp

Kod
Code
AL

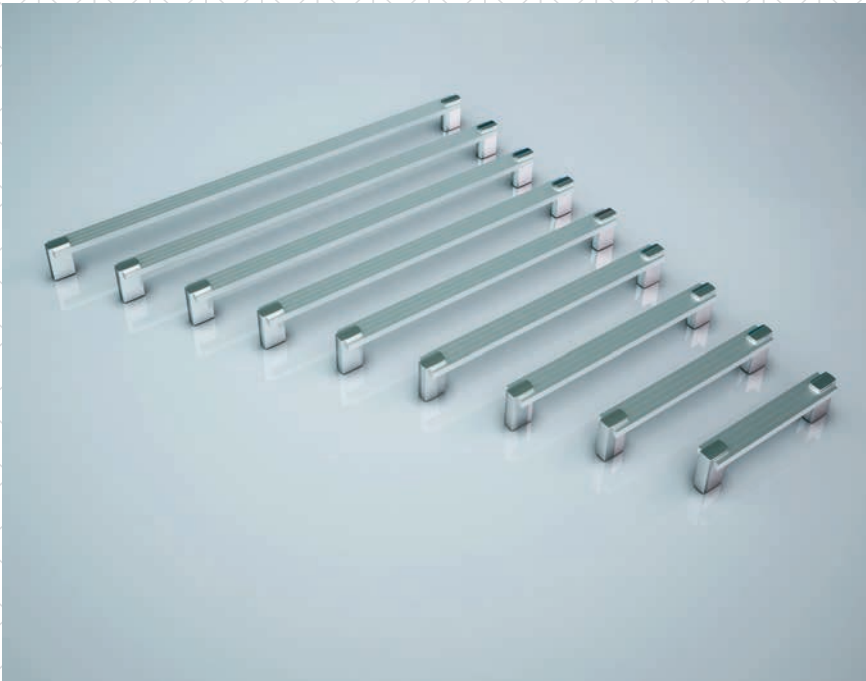

Ölçüler (mm)
Sizes

96
128
160
192
224
256
288
320
352

Metal Renkler
Metal Colors

02 Krom

Metal Renkler
Metal Colors



Kr Kulp

Kod
Code
KR

Ölçüler (mm)
Sizes

96
128
160
192
224

Metal Renkler
Metal Colors

02 Krom
22 Mat Krom
17 Saten

Metal Renkler
Metal Colors

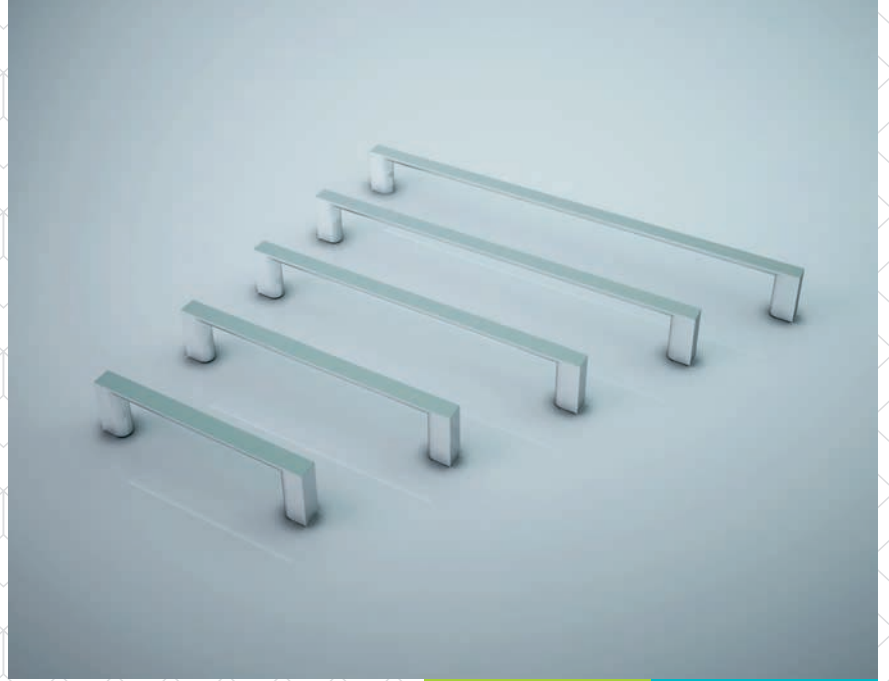
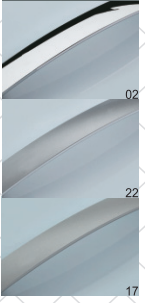

Kod
Code
LM

Lama

Ölçüler (mm)
Sizes

96
128
160
192
224

Metal Renkler
Metal Colors

02 Krom
22 Mat Krom
17 Saten

Metal Renkler
Metal Colors

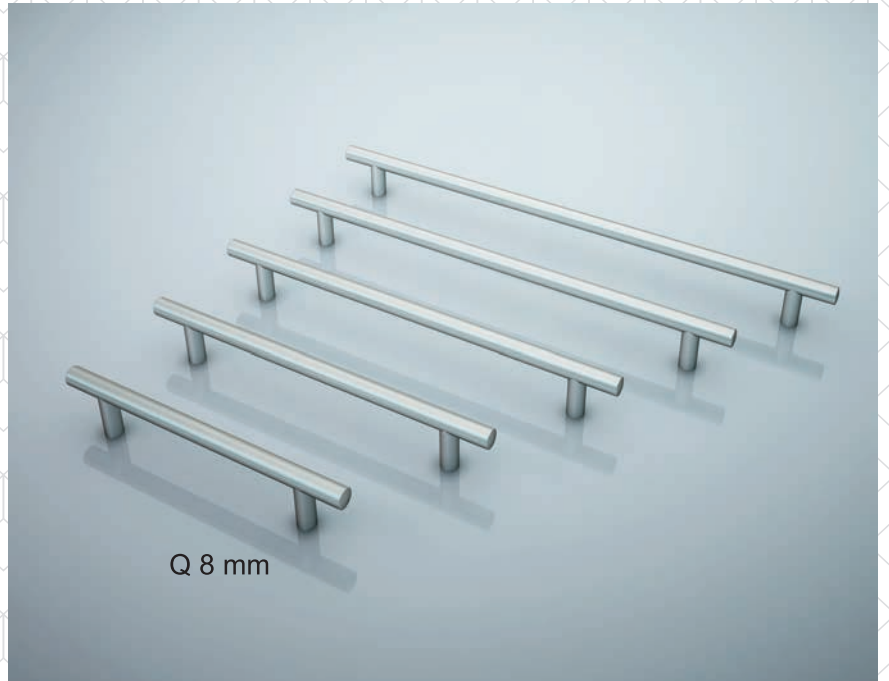
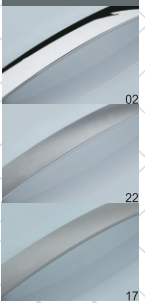

Kod
Code
Ç

Çubuk

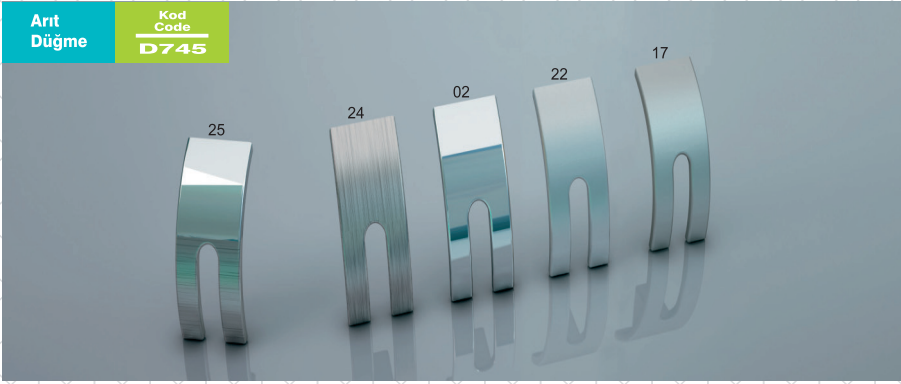

Ölçüler (mm)
Sizes

Metal Renkler
Metal Colors

- 25 Krom İnox
24 İnox
02 Krom
22 Mat Krom
17 Saten

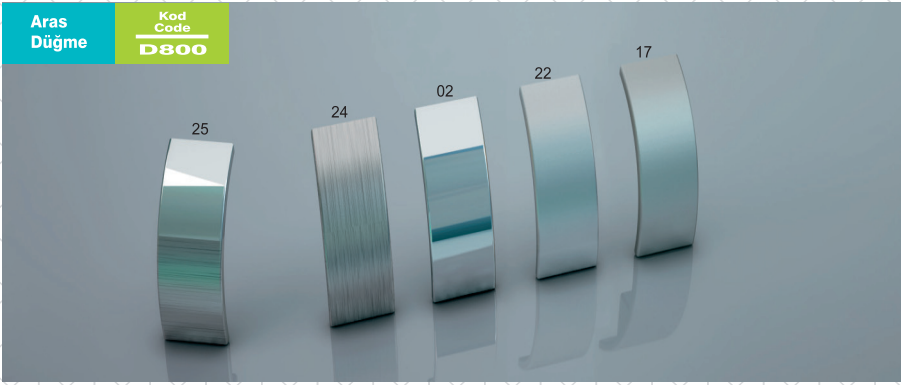

Ölçüler (mm)
Sizes

Metal Renkler
Metal Colors

- 25 Krom İnox
24 İnox
02 Krom
22 Mat Krom
17 Saten

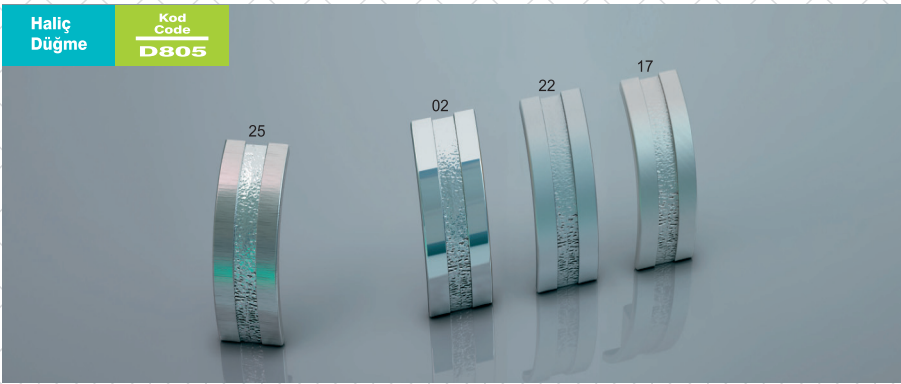

Ölçüler (mm)
Sizes

Metal Renkler
Metal Colors

- 25 Krom İnox
02 Krom
22 Mat Krom
17 Saten



Ölçüler (mm)
Sizes

Metal Renkler
Metal Colors

- 18 Antik Bakır
23 Antik Sarı

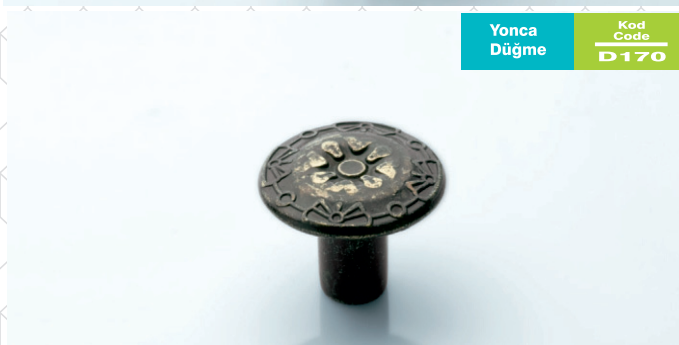

Ölçüler (mm)
Sizes

Metal Renkler
Metal Colors

02 Krom
22 Mat Krom
17 Saten
18 Antik Bakır
23 Antik Sarı

Büyük Sarıklı Askı

Kod Code
A122



Ölçüler (mm)
Sizes

Metal Renkler
Metal Colors

-
- 02 Krom
- 22 Mat Krom
- 17 Saten
- 10 Sarı
- 18 Antik Bakır
- 23 Antik Sarı

Klasik Askı

Kod Code
A128



Ölçüler (mm)
Sizes

Metal Renkler
Metal Colors

-
- 02 Krom
- 22 Mat Krom
- 17 Saten
- 10 Sarı
- 18 Antik Bakır
- 23 Antik Sarı

Lüks Askı

Kod Code
A132

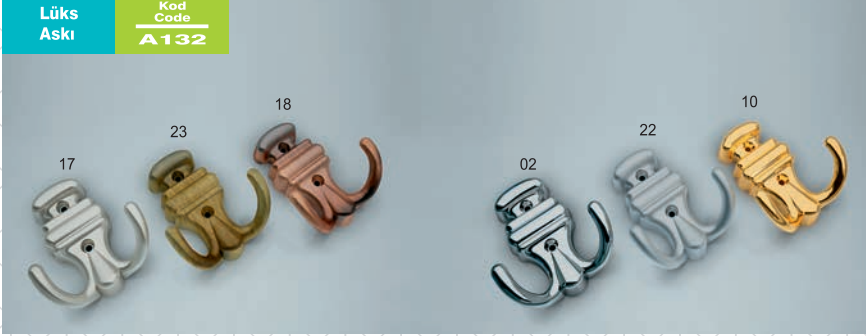

Ölçüler (mm)
Sizes

Metal Renkler
Metal Colors

-
- 02 Krom
- 22 Mat Krom
- 17 Saten
- 10 Sarı
- 18 Antik Bakır
- 23 Antik Sarı

Şah Askı

Kod Code
A136



Ölçüler (mm)
Sizes

Metal Renkler
Metal Colors

-
- 02 Krom
- 22 Mat Krom
- 17 Saten
- 10 Sarı
- 18 Antik Bakır
- 23 Antik Sarı

Büyük Kurbaga Askı

Kod Code
A124

Küçük Kurbaga Askı

Kod Code
A146



Ölçüler (mm)
Sizes

Metal Renkler
Metal Colors

-
- 02 Krom
- 22 Mat Krom
- 17 Saten
- 10 Sarı
- 18 Antik Bakır
- 23 Antik Sarı

Ölçüler (mm)
 Sizes

 Metal Renkler
 Metal Colors

- 02 Krom
- 22 Mat Krom
- 17 Saten
- 10 Sarı
- 18 Antik Bakır
- 23 Antik Sarı

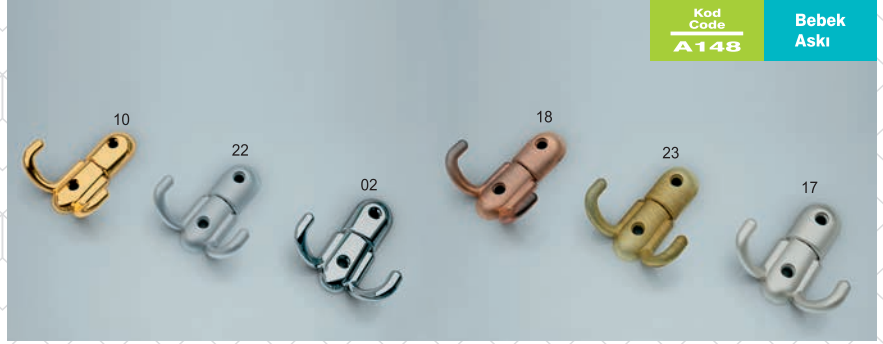
 Kod Code
A148
Bebek Askı

 Ölçüler (mm)
 Sizes

 Metal Renkler
 Metal Colors

- 02 Krom
- 22 Mat Krom
- 17 Saten
- 10 Sarı
- 18 Antik Bakır
- 23 Antik Sarı

 Kod Code
A150
Düz Askı

 Ölçüler (mm)
 Sizes

 Metal Renkler
 Metal Colors

- 02 Krom
- 22 Mat Krom
- 17 Saten
- 10 Sarı
- 18 Antik Bakır
- 23 Antik Sarı

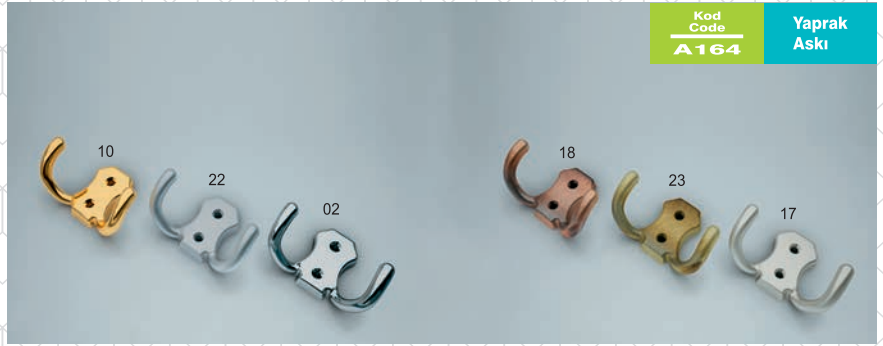
 Kod Code
A164
Yaprak Askı

 Ölçüler (mm)
 Sizes

 Metal Renkler
 Metal Colors

- 02 Krom
- 22 Mat Krom
- 17 Saten
- 10 Sarı
- 18 Antik Bakır
- 23 Antik Sarı

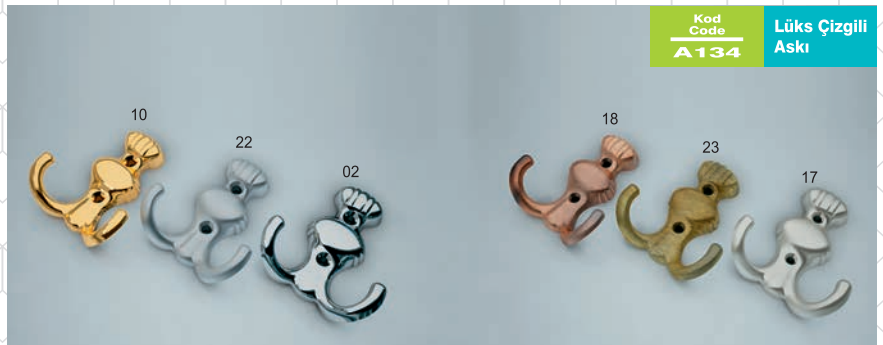
 Kod Code
A134
Lüks Çizgili Askı

 Ölçüler (mm)
 Sizes

 Metal Renkler
 Metal Colors

- 02 Krom
- 22 Mat Krom
- 17 Saten
- 10 Sarı
- 18 Antik Bakır
- 23 Antik Sarı

 Kod Code
A175
V Askı

Tavşan Askı

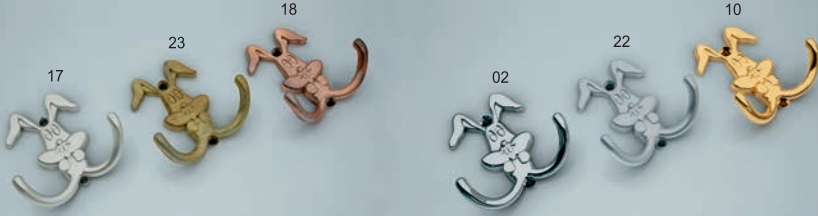
 Kod
Code
A180

 Ölçüler (mm)
Sizes

-

 Metal Renkler
Metal Colors

 02 Krom
22 Mat Krom
17 Saten
10 Sarı
18 Antik Bakır
23 Antik Sarı

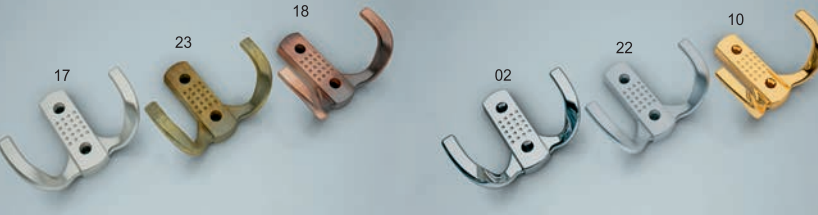
Noktalı Askı

 Kod
Code
A240

 Ölçüler (mm)
Sizes

-

 Metal Renkler
Metal Colors

 02 Krom
22 Mat Krom
17 Saten
10 Sarı
18 Antik Bakır
23 Antik Sarı

Hilal Askı

 Kod
Code
A405

 Ölçüler (mm)
Sizes

-

 Metal Renkler
Metal Colors

 02 Krom
22 Mat Krom
17 Saten
10 Sarı
18 Antik Bakır
23 Antik Sarı

Lale Askı

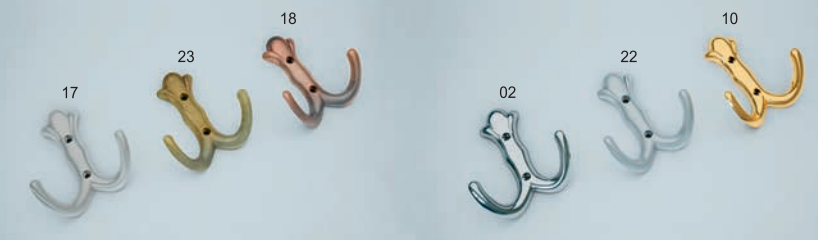
 Kod
Code
A126

 Ölçüler (mm)
Sizes

-

 Metal Renkler
Metal Colors

 02 Krom
22 Mat Krom
17 Saten
10 Sarı
18 Antik Bakır
23 Antik Sarı

İstanbul Askı

 Kod
Code
A190

 Ölçüler (mm)
Sizes

-

 Metal Renkler
Metal Colors

 02 Krom
22 Mat Krom
17 Saten
10 Sarı
18 Antik Bakır
23 Antik Sarı

Ölçüler (mm) Sizes	Metal Renkler Metal Colors
-	02 Krom 22 Mat Krom 17 Saten 10 Sarı 18 Antik Bakır 23 Antik Sarı



Ölçüler (mm) Sizes	Metal Renkler Metal Colors
-	02 Krom 22 Mat Krom 17 Saten 10 Sarı 18 Antik Bakır 23 Antik Sarı

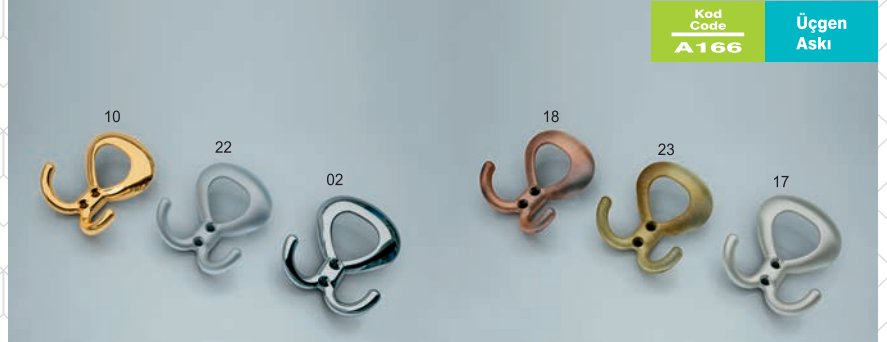

Ölçüler (mm) Sizes	Metal Renkler Metal Colors	Plastik Renkler Plastic Colors
-	02 Krom 22 Mat Krom 17 Saten	01 Akça Ağaç 02 Kayın 03 Armut 04 Kiraz 05 Maun 06 Venge 07 Ceviz

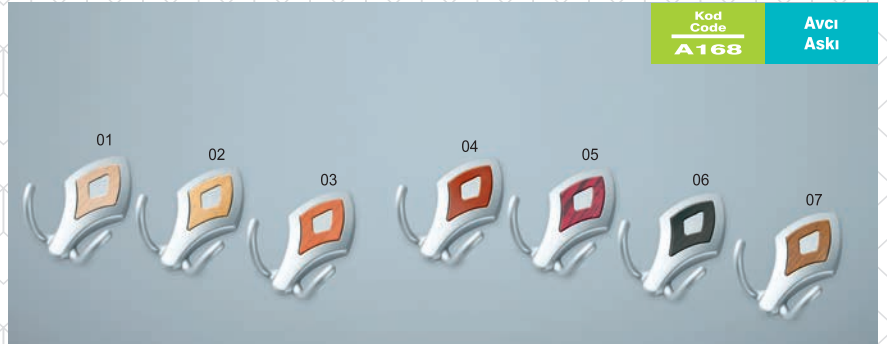

Ölçüler (mm) Sizes	Metal Renkler Metal Colors	Plastik Renkler Plastic Colors
-	02 Krom 22 Mat Krom 17 Saten	01 Akça Ağaç 02 Kayın 03 Armut 04 Kiraz 05 Maun 06 Venge 07 Ceviz

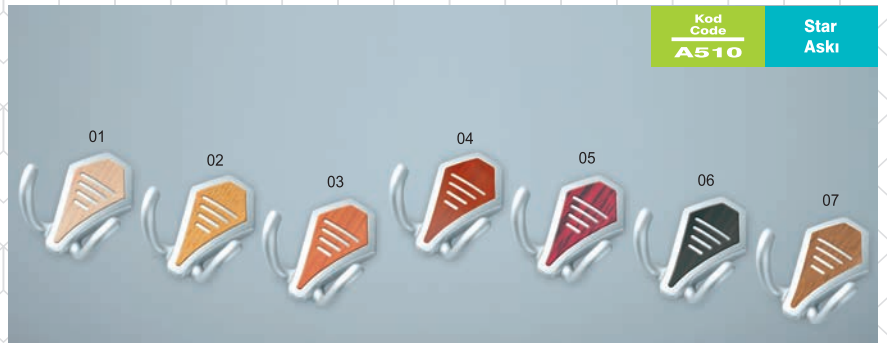

Ölçüler (mm) Sizes	Metal Renkler Metal Colors	Plastik Renkler Plastic Colors
-	02 Krom 22 Mat Krom 17 Saten	01 Akça Ağaç 02 Kayın 03 Armut 04 Kiraz 05 Maun 06 Venge 07 Ceviz

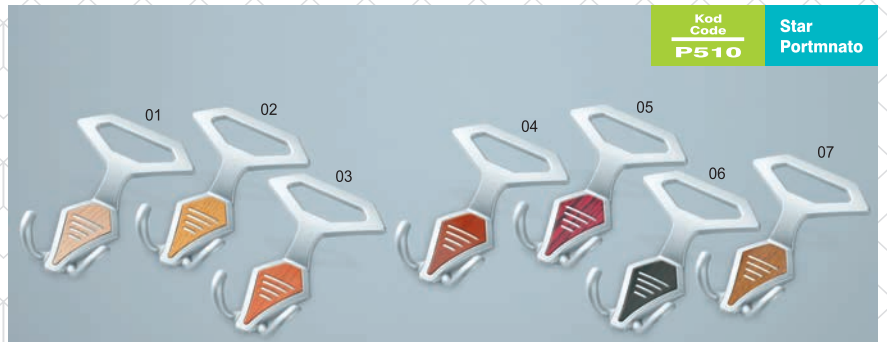



Ölçüler (mm)
Sizes

-

Metal Renkler
Metal Colors

02 Krom
22 Mat Krom
17 Saten
10 Sarı
18 Antik Bakır
23 Antik Sarı

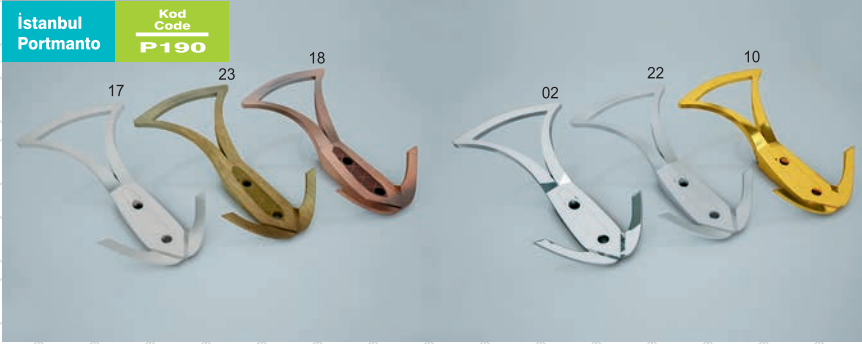

Ölçüler (mm)
Sizes

-

Metal Renkler
Metal Colors

02 Krom
22 Mat Krom
17 Saten
10 Sarı
18 Antik Bakır
23 Antik Sarı

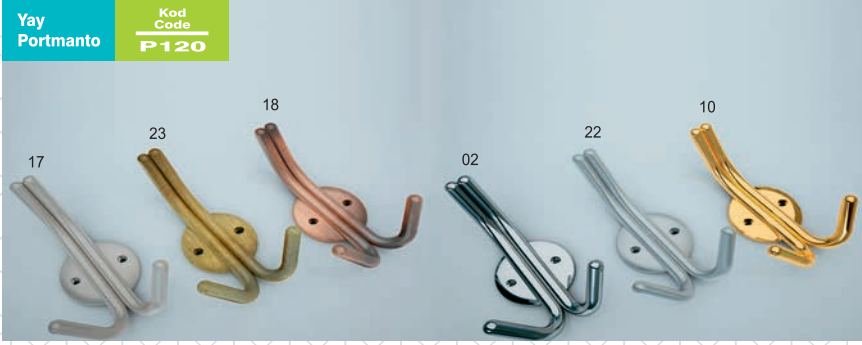

Ölçüler (mm)
Sizes

-

Metal Renkler
Metal Colors

02 Krom
22 Mat Krom
17 Saten
10 Sarı
18 Antik Bakır
23 Antik Sarı

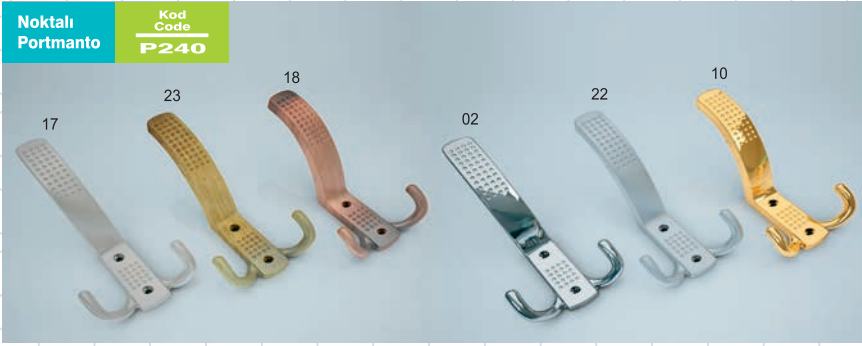

Ölçüler (mm)
Sizes

-

Metal Renkler
Metal Colors

02 Krom
22 Mat Krom
17 Saten
10 Sarı
18 Antik Bakır
23 Antik Sarı



Ölçüler (mm)
Sizes

-

Metal Renkler
Metal Colors

02 Krom
22 Mat Krom
17 Saten
10 Sarı
18 Antik Bakır
23 Antik Sarı

Ölçüler (mm) Sizes	Metal Renkler Metal Colors
-	02 Krom 22 Mat Krom 17 Saten 10 Sarı 18 Antik Bakır 23 Antik Sarı



Ölçüler (mm) Sizes	Metal Renkler Metal Colors
-	02 Krom 22 Mat Krom 17 Saten 10 Sarı 18 Antik Bakır 23 Antik Sarı



Ölçüler (mm) Sizes	Metal Renkler Metal Colors
-	02 Krom 22 Mat Krom 17 Saten 10 Sarı 18 Antik Bakır 23 Antik Sarı



Ölçüler (mm) Sizes	Metal Renkler Metal Colors
-	02 Krom 22 Mat Krom 17 Saten 10 Sarı 18 Antik Bakır 23 Antik Sarı

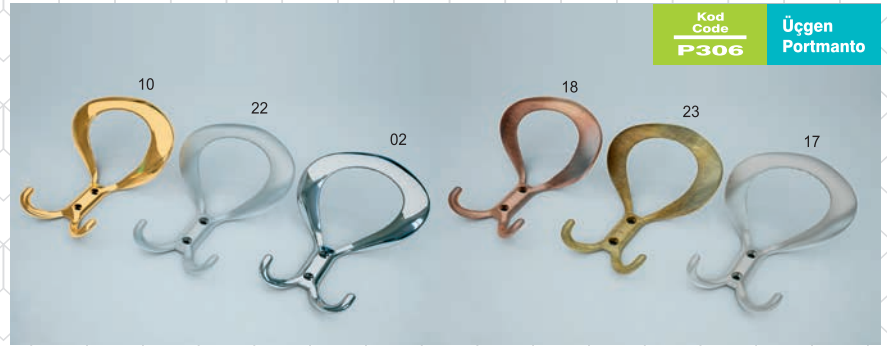

Kavele Çivi - 48 mm / Ç404



Kavele Çivi - 38 mm / Ç402

Kelebek Menteşe / M352



Eko Konik Ayak / M5



Eko Konik Ayak / M8



Eko Konik Ayak / M10



Konik Ayak / K5



Konik Ayak / K8



Konik Ayak / K10



Konik Ayak / K12



Düz Ayak / D10



Eğri Ayak / E10



Eğri Ayak / E12



Vidasız Flanş / FO1



Vidalı Flanş / FO2



Eko Vidalı Flanş / FE02



Kapaklı Flanş / FO3



T Bağlantı / T1



Açılı Bağlantı / AB



Kapalı Flanş / B504



Açık Flanş / B506



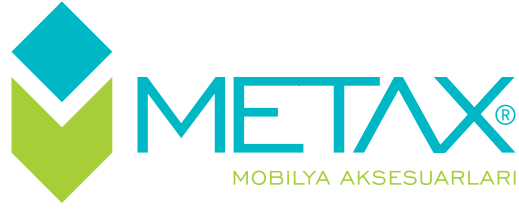

© 2011 Copyright
All Rights Reserved

Tüm hakları saklıdır, kısmen veya tamamen alıntı yapılamaz.
Özmetal-İş San. ve Tic. Ltd. Şti. tüm ürün ve fiyatlarında
önceden haber vermeksizin değişiklik yapma hakkını saklı tutar.

Katalog yapımında emeği geçenler

Mustafa TEKİR
Necdet KARAARSLAN
Ercan BAŞARAN
Ersan EVCİMEN